

EyeLink[®] 1000 Plus User Manual

**Desktop, LCD Arm, Tower, Primate
and Long Range Mounts**





**Remote, 2000 Hz and Fiber Optic
Camera Upgrades**

Version 1.0.12



Copyright ©2013-2017, SR Research Ltd.

EyeLink is a registered trademark of SR Research Ltd.,
Mississauga, Ontario, Canada

	Read instructions before use.
	For indoor use only.
	Intertek Safety Mark: Compliance of this product with applicable standards is certified by Intertek, an independent testing agency.
	Separate electrical and electronic collection.
<div style="border: 2px solid black; padding: 5px; text-align: center;"> <p>CLASS 1 LED DEVICE IEC 60825-1 (Ed. 1.2:2001)</p> </div>	Illuminators comply with 60825-1 or 62471 safety standards. Refer to Chapter 6 of the User Manual.
<div style="border: 2px solid black; padding: 5px; text-align: center;"> <p>CLASS 1 LASER DEVICE IEC 60825-1 (Ed. 1.2:2001)</p> </div>	Fiber optic interface to OC camera head complies with FDA and IEC laser safety standards. Refer to Chapter 6 of the User Manual.

FCC Statement:

NOTE: This equipment has been tested and found to comply with the limits for a Class A digital device, pursuant to part 15 of the FCC Rules. These limits are designed to provide reasonable protection against harmful interference when the equipment is operated in a commercial environment. This equipment can radiate radio frequency energy and may cause harmful interference to radio communications. Operation of this equipment in a residential area is likely to cause harmful interference in which case the user will be required to correct the interference at the users' expense.

CISPR WARNING: This is a Class A product. In domestic environments this product may cause radio interference in which case the user may be required to take adequate measures.

WARNING: Changes or modifications not expressly approved by SR Research Ltd. could void the user's warranty and authority to operate the equipment. This includes modification of cables, removal of ferrite chokes on cables, or opening cameras or connectors.

WARNING: Opening or modifying cameras and connector will void the warranty and may affect safety compliance of the system. No user-serviceable parts inside - contact SR Research for all repairs.



Caution – Using controls or adjustments or performance of procedures other than those specified herein may result in hazardous radiation exposure. Refer to Chapter 6 of User Manual

This product complies with FDA performance standards for laser products, except for deviations pursuant to Laser Notice No. 50, dated June 24, 2007.

CONTACT ADDRESS

SR Research Ltd
35 Beaufort Drive
Ottawa, Ontario, K2L 2B9
Canada

Fax: (613) 482-4866
Phone: (613) 271-8686
Toll Free: 1-866-821-0731 (North America only)
Email: support@sr-research.com
Sales: <http://www.sr-research.com>
Support: <http://www.sr-support.com>

Table of Contents

1. Introduction	1
1.1 Supporting Documents	3
1.2 EyeLink 1000 Plus System Configuration	4
1.2.1 Host PC.....	4
1.2.2 Display PC	5
1.2.3 EyeLink 1000 Plus Camera Mount Configurations	6
1.3 System Specifications	9
1.3.1 Operational / Functional Specifications.....	9
1.3.2 Physical Specifications.....	10
2. EyeLink 1000 Plus Host Software	12
2.1 Web UI Interface	12
2.1.1 File Manager	12
2.1.2 Configuration Tool.....	17
2.1.3 Tracker Initialization Files.....	19
2.1.4 Running Web UI on a computer other than the host PC.....	20
2.2 Starting the Host Application	21
2.3 Modes of Operation	22
2.4 EyeLink 1000 Plus Host PC Navigation	23
2.4.1 Camera Setup Screen.....	24
2.4.2 Offline Screen	30
2.4.3 Set Options Screen	32
2.4.4 Calibrate Screen	40
2.4.5 Validate Screen.....	43
2.4.6 Drift Check/Drift Correct Screen.....	45
2.4.7 Output Screen	46
2.4.8 Record Screen	48
2.5 Status Panel	54
2.6 Mouse Simulation Mode.....	55
3. An EyeLink 1000 Plus Tutorial: Running an Experiment	56
3.1 The Camera Setup Screen.....	57
3.2 Participant Setup	58
3.2.1 Desktop Mount Participant Setup, Monocular.....	59

3.2.2	<i>Desktop Mount Participant Setup, Binocular</i>	62
3.2.3	<i>Desktop Mount Participant Setup, Monocular Remote Mode</i>	63
3.2.4	<i>Desktop Mount Participant Setup, Binocular Remote Mode</i>	71
3.2.5	<i>LCD Arm Mount Participant Setup</i>	72
3.2.6	<i>Tower Mount Participant Setup, Monocular or Binocular</i>	73
3.2.7	<i>Primate Mount Participant Setup, Monocular or Binocular</i>	76
3.2.8	<i>Long Range Mount Participant Setup, Monocular or Binocular</i>	76
3.3	Setting Pupil Thresholds	79
3.4	Setting the Corneal Reflection (CR) Threshold	81
3.5	Search Limits	82
3.6	Pupil Tracking Algorithm	82
3.7	Calibration	83
3.8	Validation	87
3.9	Improving Calibration Quality	89
3.10	Recording Gaze Position	90
3.11	Drift Checking and Drift Correction	91
3.11.1	<i>Enabling Drift Correction</i>	91
3.11.2	<i>Online Drift Correction</i>	92
3.12	Exiting the Host Application	95
3.13	EyeLink 1000 Plus Setup Summary	95
3.14	Experiment Practice	96
3.15	Next Steps: Other Sample Experiments	97
4.	Data Files	100
4.1	File Contents	100
4.2	Recording EDF Files	101
4.2.1	<i>Recording from the EyeLink 1000 Plus Host PC</i>	101
4.2.2	<i>Recording from the EyeLink API or SR Research Experiment Builder</i>	101
4.3	The EyeLink On-Line Parser	101
4.3.1	<i>Parser Operation</i>	101
4.3.2	<i>Parser Limitations</i>	102
4.3.3	<i>EyeLink Parser Configuration</i>	102
4.3.4	<i>Parser Data Type</i>	103
4.3.5	<i>Saccadic Thresholds</i>	103
4.3.6	<i>Pursuit Thresholds</i>	104

4.3.7	<i>Fixation Updates</i>	104
4.3.8	<i>Other Parameters</i>	105
4.3.9	<i>Sample Configurations</i>	105
4.3.10	<i>Reparsing EyeLink Data Files</i>	106
4.4	File Data Types	107
4.4.1	<i>Samples</i>	107
4.4.2	<i>Position Data</i>	107
4.4.3	<i>Pupil Size Data</i>	110
4.4.4	<i>Button Data</i>	110
4.5	Events	111
4.5.1	<i>Messages</i>	111
4.5.2	<i>Buttons</i>	111
4.5.3	<i>Eye Movement Events</i>	112
4.6	Setting File Contents	116
4.6.1	<i>Sample Data</i>	116
4.6.2	<i>Event Data</i>	117
4.6.3	<i>Event Types</i>	117
4.7	EDF File Utilities	118
4.8	Using ASC Files	118
4.9	The ASC File Format	119
4.9.1	<i>ASC File Structure</i>	119
4.9.2	<i>Sample Line Format</i>	120
4.9.3	<i>Event Line Formats</i>	123
4.9.4	<i>Data-Specification Lines</i>	126
4.10	Processing ASC Files	127
5.	System Care	129
5.1	Maintenance	129
5.2	Storage and Transportation	129
6.	Important Information	130
6.1	Safety	130
6.1.1	<i>Eye Illumination Safety</i>	130
6.2	Servicing Information	131
6.2.1	<i>Non-Serviceable Components:</i>	132
6.2.2	<i>Illuminator Replacement:</i>	132

6.2.3	<i>Cables and Lenses:</i>	132
6.2.4	<i>Power Supply Replacement:</i>	133
6.3	Limited Hardware Warranty	134
6.4	Limited Software Warranty	135
6.5	Copyrights / Trademarks	136
7.	Appendix A: Using the EyeLink 1000 Plus Analog and Digital Output Card ..	137
7.1	Analog Data Types	137
7.2	Analog Data Quality	138
7.3	Setting up the EyeLink 1000 Plus Analog Card	138
7.3.1	<i>Installing Analog Output Hardware</i>	138
7.3.2	<i>Connections to Analog Card</i>	139
7.3.3	<i>Noise and Filtering</i>	140
7.4	Digital Inputs and Outputs	140
7.4.1	<i>Analog Data Output Assignments</i>	141
7.4.2	<i>Analog Data Types and Ranges</i>	141
7.4.3	<i>Scaling of Analog Position Data</i>	142
7.5	Pupil Size Data	143
7.6	Timebase and Data Strobe	143
7.6.1	<i>Strobe Data Input</i>	143
7.6.2	<i>Oversampling and Toggle Strobe</i>	144

List of Figures

Figure 1-1: Typical EyeLink 1000 Plus Configuration with a Desktop Mount	2
Figure 1-2: EyeLink 1000 Plus Desktop Mount.....	6
Figure 1-3: EyeLink 1000 Plus Binocular Tower Mount	6
Figure 1-4: EyeLink 1000 Plus Primate Mount and Diagram of a Typical Setup	7
Figure 1-5: EyeLink 1000 Plus LCD Arm Mount	7
Figure 1-6: Typical EyeLink 1000 Plus Long Range Mount Configuration.....	8
Figure 2-1: File Manager Screen.....	13
Figure 2-2: Booting into the EyeLink Partition	21
Figure 2-3: EyeLink 1000 Plus Host PC Application Overview	24
Figure 2-4: Example Camera Setup Screen.....	24
Figure 2-5: Example Offline Screen	31
Figure 2-6: Example Set Options Screen	32
Figure 2-7: Example Calibrate Screen	41
Figure 2-8: Example Validate Screen.....	43
Figure 2-9: Example Drift Check/Drift Correct Screen.....	45
Figure 2-10: Example EyeLink 1000 Plus Output Screen.....	47
Figure 2-11: Example Record Screen (Gaze Cursor View).....	49
Figure 2-12: Example Record Screen (Plot View).....	49
Figure 2-13: Gain/Offset Adjustments in the Plot View.....	54
Figure 2-14: EyeLink 1000 Plus Status Panel.....	54
Figure 3-1: Example Camera Setup Screen (Desktop Mount).	57
Figure 3-2: Parts of the EyeLink 1000 Plus Desktop Mount	60
Figure 3-3: Camera Setup with Participants Wearing Glasses	61
Figure 3-4: Focusing the Desktop Mount Camera.....	62
Figure 3-5: Camera Setup Screen Desktop Mount, Binocular Recording	63
Figure 3-6: Camera Setup Screen with the Monocular Remote Mode	65
Figure 3-7: EyeLink Remote Target Placement.....	67
Figure 3-8: Pupil and CR Thresholds and Bias Values	68
Figure 3-9: Status Panel Pupil Size Information.....	70
Figure 3-10: Target and Eye Positions in the Thumbnail Camera Images	71
Figure 3-11 Camera Setup Screen with the Binocular Remote Mode.....	72
Figure 3-12: Parts of the EyeLink 1000 Plus Tower Mount.....	74

Figure 3-13: Adjust the Chair Height for EyeLink 1000 Plus Tower Mount.....	75
Figure 3-14: Focusing the Eye Camera for EyeLink 1000 Plus Binocular Tower Mount	76
Figure 3-15: Adjusting the Camera Image Orientation	77
Figure 3-16: Symptoms of Poor Pupil Threshold	79
Figure 3-17: Corner Effects Seen with Head Rotation	80
Figure 3-18: Corneal Reflection	81
Figure 3-19: Calibration Grid	85
Figure 3-20: Performing a drift correction using mouse click	93
Figure 7-1 Screw Terminal Panel Pin Mapping Table	139

List of Tables

Table 1: EyeLink 1000 Plus Configuration Files.....	20
Table 2: Lens Guide for Different Viewing Distances	40
Table 3: Table of Recommended Distance from Illuminator.....	131
Table 4: Analog Channel Data Assignments for the EyeLink 1000 Plus hardware	141

1. Introduction

This section introduces the technical capabilities and supporting documentation for the EyeLink® 1000 Plus eye tracker. The EyeLink 1000 Plus can be used in several configurations, each with its own strengths and capabilities, allowing a single base system to suit a wide variety of research applications. The same camera technology and software supports all configurations, making the EyeLink 1000 Plus the most versatile solution for eye and gaze monitoring available. Each EyeLink 1000 Plus configuration shares the same application programming interface (API) and EyeLink Data File (EDF) output, allowing experimenters to seamlessly switch between data collection and analysis modes that best suit their particular experimental paradigm or to accommodate different participant populations.

The EyeLink 1000 Plus high-speed camera has been designed to interchangeably fit into different mounting options (with the exception that an additional Fiber Optic Camera Head is required with the Long Range Mount). This means that the purchase of a single Base System plus an array of mounts, allows the same eye tracker to be used in a wide range of settings from high precision recording in the laboratory with the head stabilized, through Remote recording without head stabilization, to sensitive and specialized recording environments like MRI or MEG settings. In all of these modes the unprecedented low noise, stability and the world's fastest sampling rates are available. The EyeLink 1000 Plus is truly a multipurpose eye tracking solution.

The EyeLink 1000 Plus camera can be affixed to a Desktop Mount that provides highly accurate monocular or binocular data acquisition at up to 2000 Hz (with the 2000 Hz camera upgrade) using a chinrest. In addition, the cameras can be configured in a redesigned Tower Mount that allows highly accurate monocular or binocular recordings with a wide field of view when the participant's head is supported by a chin and forehead rest. A third mounting option is the LCD Arm Mount that affixes the EyeLink 1000 Plus beneath an LCD monitor on a flexible arm so that the entire eye tracking apparatus and display can be easily moved into place in front of the viewer whose eyes are to be tracked. The Long Range Mount with the Fiber Optic Camera can be used at distances up to 150 cm from the eye for electromagnetic sensitive environments (e.g., EEG or MEG) or environments where metal content needs to be minimized (e.g., MEG or MRI). Finally, the Primate mount provides a mounting option for the camera so that placement can be out of the way and above the participant, making it ideal for use in animal recording situations.

The Desktop and LCD Arm Mounts can be used in a highly flexible Remote Mode (with the Remote Camera option) to record gaze position at up to 1000 Hz without head stabilization. Combined with the LCD Arm Mount, Remote Mode is ideal for reaching viewers in difficult to record positions as it brings the eye tracker and display to the participant instead of making the viewer conform to the setup required by the eye tracker. The fact that Remote recording operates without head stabilization further increases the system's flexibility.

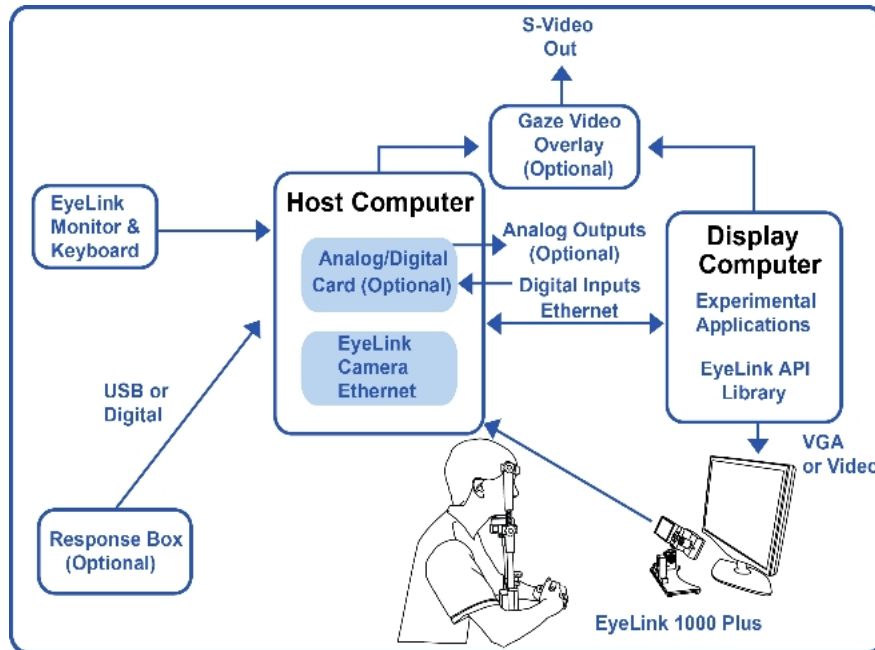

Figure 1-1: Typical EyeLink 1000 Plus Configuration with a Desktop Mount

All configurations of the EyeLink 1000 Plus operate at the unparalleled low variability required for accurate gaze contingent paradigms, and the highly accurate and sensitive operation that careful research demands. EyeLink systems are the only modern equipment to run on a real-time operating system for low variability and near-instant access to eye data measures. Although Remote recording understandably has more noise than head stabilized recording, it nevertheless continues to be highly accurate, though of lower resolution. Compared to other remote systems on the market, the EyeLink Remote operates at much higher acquisition rates (up to 1000 Hz), translating into fewer missed data points, all with no moving parts to interfere with stimulus delivery and invalidate the experimental setting.

A typical EyeLink setup is depicted in Figure 1-1. This figure illustrates the Desktop Mount. The system consists of two computers – one, the Host PC is dedicated to data collection. The second computer is referred to as the Display PC, and is generally used for the presentation of stimuli to a participant. The

two computers are connected via an Ethernet link that allows the sharing of critical information from the Host PC to the Display PC, such as the occurrence of eye events, gaze position, or images from the camera during participant setup. Similarly, the Display PC can communicate with the Host PC, allowing Display PC applications to direct the collection of data. An optional EyeLink button box can be attached directly to the Host PC allowing for the accurate synchronization of participant responses with the eye movement data. Message passing also allows events collected by I/O devices on the Display PC (e.g., button boxes, microphones, etc.) to be accurately recorded in the data file.

IMPORTANT: Please examine the safety information for the EyeLink 1000 Plus system, found in Section 6.1.

1.1 Supporting Documents

The EyeLink 1000 Plus User Guide (this document) contains information on using the EyeLink 1000 Plus hardware, the Host PC application, tutorials on participant setup and calibration, and the basics of running an experiment. Information on system safety, maintenance, and storage is also provided. Appendix A of this manual explains the use of the optional analog output and digital inputs and outputs via an analog card.

Additional documents are also available:

- A. EyeLink 1000 Plus Installation Guide – Describes a standard EyeLink 1000 Plus system layout and environmental considerations as well as the process followed to install the EyeLink 1000 Plus hardware and software on both the Host and Display PCs.
- B. EyeLink Programmer's Guide – Provides suggestions on how to program experiments with EyeLink 1000 Plus in Windows, including a review of sample experiments and documentation of supported functions.
- C. SR Research Experiment Builder User Manual – Introduces an optional visual experiment creation tool for creating EyeLink experiments on 32-/64-bit Windows and Mac OS X. This software allows for a wide range of sophisticated experimental paradigms to be created by someone with little or no programming or scripting expertise.
- D. EyeLink Data Viewer User's Manual – Introduces an optional Data analysis tool, EyeLink Data Viewer, which allows interactive display, filtering, extraction and summarizing of EyeLink EDF data.

NOTE: Please be sure to check <http://www.sr-support.com> for product and documentation updates as they become available.

1.2 EyeLink 1000 Plus System Configuration

1.2.1 Host PC

The EyeLink 1000 Plus Host PC performs real-time eye tracking at 250, 500, 1000, or 2000 samples per second¹ while computing true gaze position on the display viewed by the participant. The Host PC also performs on-line detection and analysis of eye-motion events such as saccades, blinks, and fixations. In addition to the sample data, these events are stored in a data file on the Host PC. They can be sent through the Ethernet link to the Display PC with a minimal delay, or output as analog signals (if the optional analog/digital I/O card is installed). From the Host PC, the operator performs participant setup, monitors their performance, and can communicate with applications running on a Display PC.

The Host PC:

- uses a timing-sensitive operating system allowing the eye tracker to minimize delays in data acquisition and transmission and provide very low data access variability.
- functions either as standalone eye tracker or connected to a Display PC via Ethernet.
- communicates with the EyeLink camera using a Gigabit network connection (through the onboard network card on a Laptop Host PC or a dedicated add-on card on a Workstation Host PC). A workstation Host PC can also house an optional analog output/digital input card.
- can operate in a standalone configuration, where data can be directed through an optional analog output card and/or digitally stored on the hard disk.
- supports an optional button box (USB or parallel port) for highly accurate response recording synchronized with eye movement data.
- software integrates all the eye tracking functionality, including participant setup, calibration, sending real-time data through an Ethernet link or optional analog output card, and data recording.
- can be configured remotely via commands sent over the Ethernet link.

¹ Availability of some sampling rates depends on the mount type and system licensing.

- can show real-time feedback of eye data during calibration or recording, allowing other network devices to be devoted to accurate stimulus delivery.

1.2.2 Display PC

The Display PC presents stimuli during experiments and, via the Ethernet Link, can control key eye tracking functionality such as calibration, data collection, etc. On-line eye and gaze position can be received from the EyeLink Host PC via the Ethernet link making gaze-contingent paradigms possible. Licenses can be acquired from SR Research for Experiment Builder, a sophisticated program that assists researchers in creating EyeLink experiments on Windows and Mac OS X without programming everything from scratch.

For users who wish to program their own experiments, a wide range of programming options exist for assisting in automated data acquisition on the Display PC. A C/C++ programming API with example code exists for Windows, Mac OS X, and Linux. Additionally, third parties have made several freely available methods to use the EyeLink with other software such as MATLAB (PC and Mac OS X via the Psychtoolbox), Presentation, and E-Prime. Other languages are supported as well, such as Python and anything with access to the Windows Common Object Model (COM) interface. For full details and links to downloadable resources, visit and join the SR Research support forums at <http://www.sr-support.com>.

The Display PC:

- runs experiment application software to control the EyeLink 1000 Plus eye tracker and present stimuli through the EyeLink programming API or SR Research Experiment Builder, allowing development of countless experimental paradigms.
- can configure and control the EyeLink tracker, and have access to real-time data including gaze position, eye movement events, and response box button presses with minimal delay and low variability in timing.
- runs applications focused on stimulus generation and control of the experiment sequence. Relying on the Host PC for data acquisition and registering responses makes millisecond-accurate timing possible, even under Windows.
- supports data file viewing and conversion tools such as EyeLink Data Viewer and EyeLink EDF2ASC converter, to assist researchers in deep analysis of the data obtained.

1.2.3 EyeLink 1000 Plus Camera Mount Configurations

The EyeLink 1000 Plus is available in five base hardware configurations (Desktop, Tower, Arm, Primate and Long Range Mounts). These configurations differ in the type of mounting used for the EyeLink 1000 Plus high-speed camera and low output infrared illuminator module. The operation of the Long Range Mount requires an additional Fiber Optic Camera Head.

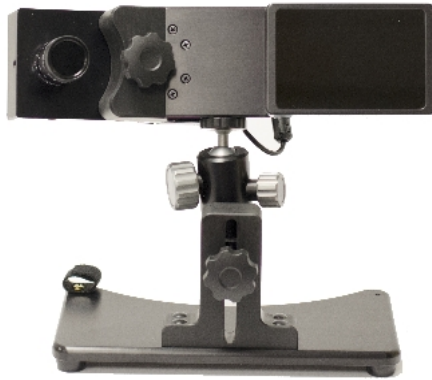

Figure 1-2: EyeLink 1000 Plus Desktop Mount

The EyeLink 1000 Plus Desktop Mount (Figure 1-2) sits below the display that the participant views during the experiment. Since the EyeLink 1000 Plus camera and the infrared illuminator are near the stimulus display, no electronics need to be near the participant's head, and any head support can be used. The Desktop Mount supports monocular, binocular, and Remote Mode eye tracking at a variety of sampling rates, depending upon the licensing options purchased.

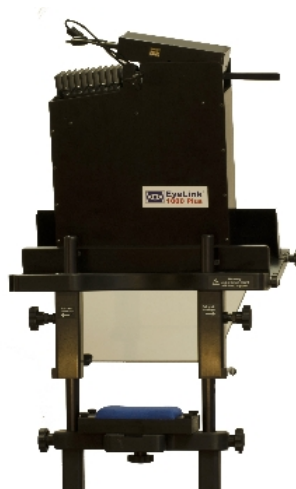

Figure 1-3: EyeLink 1000 Plus Binocular Tower Mount

The redesigned binocular-capable EyeLink 1000 Plus Tower Mount (Figure 1-3) incorporates the camera and illuminator housing within a combined chin and forehead rest via an infrared reflective mirror. The Tower Mount affords the largest field of view of all mounting systems.

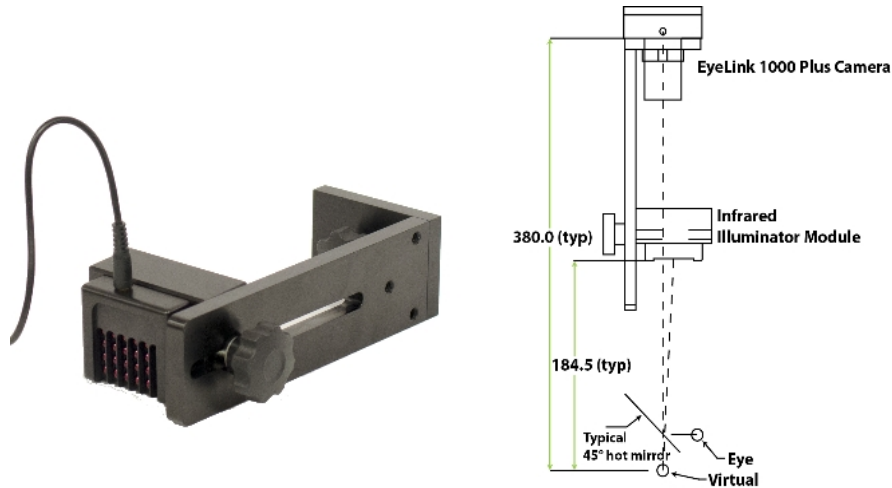

Figure 1-4: EyeLink 1000 Plus Primate Mount and Diagram of a Typical Setup

The EyeLink 1000 Plus Primate Mount (Figure 1-4 left) houses the camera and an infrared illuminator in a compact bracket that can be affixed to a vertical surface such as a primate chair. The user supplies an infrared reflecting ‘hot mirror’ to project the viewer’s eye to the camera. This allows accommodation of a wide range of unique viewing setups with very small space requirements. A typical setup appears in the diagram at the right side of Figure 1-4.



Figure 1-5: EyeLink 1000 Plus LCD Arm Mount

The EyeLink 1000 Plus LCD Arm Mount (Figure 1-5) is a fully adjustable arm holding a 17" LCD monitor with the camera and illuminator mounted beneath it. When fixed on a sturdy table the entire apparatus can be moved in place in front of the viewer to allow access to difficult-to-track populations, or simply to hold the eye tracker at an appropriate height to accommodate viewers that vary considerably in height.



Figure 1-6: Typical EyeLink 1000 Plus Long Range Mount Configuration

The EyeLink 1000 Plus Long Range Mount (Figure 1-6) consists of a Base holding a Mounting Bar to which a Long Range Illuminator and the Fiber Optic Camera Head can be attached. The Mounting Bar can be affixed to a tripod or the supplied Base at distances up to 150 cm from the eye. The entire apparatus is designed to minimize metal content in an effort to provide unprecedented monocular and binocular eye tracking capabilities in EEG/MEG and MRI environments.

1.3 System Specifications

1.3.1 Operational / Functional Specifications

	Tower Mount /Primate Mount	Desktop and LCD Arm Mounts	
		Base System	Remote Tracking (Remote Camera Upgrade required)
Average Accuracy¹	Down to 0.15° (0.25° to 0.5° typical)	0.25-0.5° typical	
Sampling rate²	Monocular: 250,500,1000,2000 Hz Binocular: 250,500,1000,2000 Hz	Monocular: 250,500,1000 Hz Binocular: 250,500,1000 Hz	
End-to-End Sample Delay³	1000 Hz: M = 1.97 ms, SD = 0.39 ms 2000 Hz: M = 1.34 ms, SD = 0.20 ms	500 Hz: M = 3.29 ms, SD = 0.58 ms 1000 Hz: M = 2.19 ms, SD = 0.30 ms	
Blink/Occlusion Recovery	1.0 ms @ 1000 Hz 0.5 ms @ 2000 Hz	2.0 ms @ 500 Hz 1.0 ms @ 1000 Hz	
Spatial Resolution⁴	0.01°		
Noise with Participants⁵	Filter (Off/Normal/High) 1000 Hz: 0.02° / 0.01° / 0.01° 2000 Hz (monoc): 0.03° / 0.02° / 0.01° 2000 Hz (binoc): 0.04° / 0.02° / 0.02°	Filter (Off/Normal/High) 500 Hz: 0.03°/0.02°/0.01° (25 mm lens) 0.06°/0.03°/0.01° (16 mm lens) 1000 Hz: 0.05°/0.03°/0.01° (25 mm lens) 0.08°/0.04°/0.02° (16 mm lens)	
Eye Tracking Principle⁶	Dark Pupil - Corneal Reflection		
Pupil Detection Models	Centroid or Ellipse Fitting	Ellipse Fitting	
Pupil Size Resolution⁵	0.1% of diameter	0.2% of diameter (16 mm lens) 0.1% of diameter (25 mm lens)	
Gaze Tracking Range	60° horizontally, 40° vertically	Customizable Default is 32° horizontally × 25° vertically	
Allowed Head Movements Without Accuracy Reduction	±25 mm horizontal or vertical	16 mm lens: 35×35 cm at 60 cm 40×40 cm at 70 cm 25 mm lens: 22×22 cm at 60 cm 25×25 cm at 70 cm	
Optimal Camera-Eye Distance	Tower: 48 cm Primate: 30 - 45 cm	40 - 70 cm	
Infrared Wavelength	Tower: 940 nm Primate: 910 /940 nm	850 to 940 nm	
Glasses Compatibility	Good	Excellent	Good
On-line Event Parsing	Fixation / Saccade / Blink / Fixation Update		
EDF File and Link Data Types	Gaze, Raw, and HREF eye position data/ Pupil size / Online events / Buttons / Messages / Digital inputs		
Real-Time Operator Feedback	Eye position gaze cursor superimposed on static image or position traces with camera images and tracking status.		
Specifications are preliminary and subject to change without notice.			
¹ Measured with real eye fixations at multiple screen positions on a per subject basis.			
² Availability depends on having the appropriate hardware and camera programming.			
³ Time from physical event until first registered sample is available via Ethernet or Analog output. Optional data filter algorithm adds one sample delay for each filtering level.			
⁴ Measured with an artificial eye.			
⁵ Measured with real subject fixations.			
⁶ Pupil-Only tracking mode is available for use in head fixed conditions.			

1.3.2 Physical Specifications

Physical	Anodized aluminum enclosure.
GL (EyeLink 1000 Plus Camera)	Standard thread (1/4"-20) centered on optical axis from 3 sides. M8 thread on front for DM and AM mounts. Power requirements: +12VDC, 800 mA for camera alone, 1.8A maximum when used with illuminator(s). Imaging rates up to 2000 fps.
OC (Fiber Optic Camera Head)	M3 tapped holes on body. Adapter for 1/4"-20 mounting available. Supply: 3.6-5.7VDC, 700mA via LEMO connector and power harness. Imaging rates up to 2000 fps. Non-magnetic (< 0.5g of iron or nickel). Radio-quiet case and cable design for use in research environments.
FL-890, FL-940 (890/940 nm Fresnel Illuminator Module)	Standard thread (1/4"-20) at center and sides. Adjustable focus and beamwidth. Wavelength: 890 or 940 nm. Supply: 3.6-5.7VDC, 1.1A via LEMO connector and power harness. Non-magnetic (< 0.5g of iron or nickel). Radio-quiet case and cable design for use in research environments.
PM-910, PM-940 (910/940 nm Illuminator Module)	Wavelength: 910 or 940 nm. Eye illumination level: less than 1 mW/cm ² at >200mm from illuminator. Illuminators powered from camera through supplied cables.
DM-850W, DM-850L, DM-890, DM-940, AM-890, AM-940 (DM and AM Series Illuminators)	Wavelength: 850 to 940 nm. Eye illumination level: less than 1 mW/cm ² at >450mm from illuminator. Powered from camera via integrated cables.
Camera Ethernet	Cabling: Unshielded CAT5e or CAT6 cables up to 30 meters in length. Requires host computer with supported Ethernet hardware capable of gigabit speeds.
Power Supply Specifications	GL camera: 12VDC, 2A external power supply with 2.5mm coaxial ("barrel") power connector (5.5 × 2.5 × 9.5mm). OC camera head and FL illuminator: 3.6-5.6VDC@2A minimum. When used with supplied power harness, DB-9 connector is required (contact SR Research for pinout). Power supply must have EN 60950, UL 950, CSA 22.2 No. 950, or other equivalent safety approval, with LPS or Class 2 rating.
Operating conditions	10°C to 30°C, 10%-80% humidity (non-condensing) For indoor use only.
Storage conditions	-10°C to 60°C, 10%-90% humidity (non-condensing). Allow to warm to room temperature before unpacking or use after storage at temperatures below 10°C to prevent condensation.
Safety Standards	IEC 60950-1:2005 (2nd Ed.) + Am 1:2009 IEC 60825-1:1993 + A1:1997 + A2:2001 IEC 62471:2006 (1st Ed.) FDA 21 CFR laser products, under Laser Notice No. 50.
Fiber Optic Link (GL and OC modules)	Class 1 laser product, IEC 60825, CFR 21 850 nm, multimodal duplex fiber, LC connector.
Electromagnetic compatibility and immunity	FCC Part 15, Subpart B: Class A unintentional radiators (see statement below) CISPR 11:1997 and EN55011:1998 -- Class A
	

CLASS 1 LED DEVICE

IEC 60825-1 (Ed. 1.2:2001)

NOTE: This equipment has been tested and found to comply with the limits for a Class A digital device, pursuant to part 15 of the FCC Rules. These limits are designed to provide reasonable protection against harmful interference when the equipment is operated in a commercial environment. This equipment generates, uses, and can radiate radio frequency energy and, if not installed and used in accordance with the instruction manual, may cause harmful interference to radio communications. Operation of this equipment in a residential area is likely to cause harmful interference in which case the user will be required to correct the interference at the users' expense.

WARNING: Changes or modifications not expressly approved by SR Research Ltd. could void the user's warranty and authority to operate the equipment.

2. EyeLink 1000 Plus Host Software

This chapter covers the following topics applicable to the use of EyeLink 1000 Plus host software.

- Web UI interface
- Starting the host application
- Modes of operation
- Basic tracker interface

2.1 Web UI Interface

The Web User Interface (Web UI) is a tool supplied with the EyeLink 1000 Plus eye tracker that allows users to access files from the Host PC, configure eye tracker settings, and perform Host software updates. This tool can be run on both the Host PC and the Display PC. On the Host PC, you can access this interface by simply pressing (Ctrl+Alt+Q) three keys together to exit the current eye tracking session. On the display PC, you can access this interface by pointing your browser to 100.1.1.1 (detailed instructions for running the Web UI on the Display PC are provided in section 2.1.4).

The Web UI interface consists of a file manager and a configuration tool.

2.1.1 File Manager

The EyeLink 1000 Plus Host software runs on QNX, a Unix-like real-time operating system, allowing the eye tracker to minimize delays in data acquisition and transmission and providing very low data access variability. The File Manager allows the users to see how the files are organized and to copy, move, rename, download, upload, and edit files.

The File manager consists of a title bar, browser URL (if running from the display side), toolbar, tree view panel, folder view panel, and preview/edit panel (see Figure 2-1).

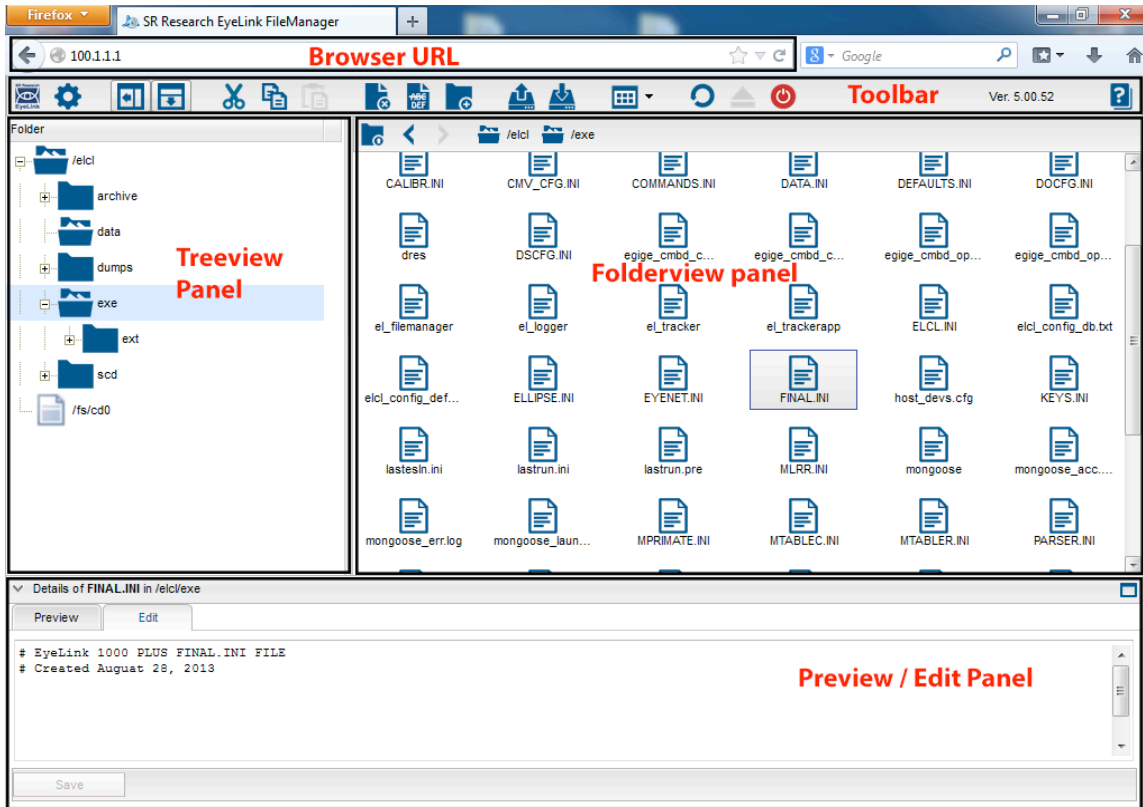



















Figure 2-1: File Manager Screen

- 1) Titlebar – this displays “SR Research EyeLink File Manager”.
- 2) Browser URL – this is configured as <http://100.1.1.1/FileManager.html> by default. This URL depends on the IP address configuration of the Host PC (100.1.1.1 is the default Host PC address).
- 3) Toolbar – this contains a list of buttons that perform actions on the currently selected files/folders. From left to right, the buttons on the toolbar are:

 Tracker	Clicking on this icon will start the EyeLink 1000 Plus Host application if the camera is properly powered up and connected.
 Configuration	Switches to the Configuration interface, allowing users to change some of the tracker settings.
 Show/Hide Tree	Toggles on/off the visibility of the Tree View panel.
 Show/Hide Preview/Edit panel	Toggles on/off the visibility of the Preview/Edit panel.

 Cut	Copies the selected file(s)/folder(s) to the clipboard. Once the file(s) are pasted into the intended folder, the original one(s) are removed. Therefore, the Cut and Paste combination can be used to move files from one folder to another.
 Copy	Copies the selected file(s)/folder(s) to the clipboard. Use the paste button to add the file(s)/folder(s) to a new location. The original file(s)/folder(s) are not removed from the old location.
 Paste	Inserts the previously cut/copied file(s) from the clipboard into the current location.
 Delete	Removes the selected file(s)/folder(s) after confirming the operation. Note: deleting will not place the items to the clipboard. Therefore, if you want to move files/folders from one location to another, you may first cut the items and then paste the selection into the intended location.
 Rename	Brings up a dialog box for you to type in a new name for the selected file or folder.
 Create New Folder	When you create a new folder, the folder is created as a child of the folder selected in the Tree View and shown in the navigation bar of the Folder View. You may use the rename button to change the folder name.
 Upload	This tool allows you to upload files to the current folder of the Host PC. Clicking on this button will bring up an Upload dialog box so that up to 10 files can be chosen to upload in one operation. This button is not available when running the file manager on the Host PC.
 Download	This tool allows you to download the selected files and folders to the local computer (typically the Display PC). Usually the target location will be the “Downloads” folder of the user account. When multiple files are selected, you may choose to have the selection compressed (default setting) to speed up the download process. This button is not available when running the file manager on the Host PC.
 View	This allows you to change the layout (Tiles vs. Details view) of the files/folders in the Folder View panel.
 Refresh	This forces an update of the entire File Manager screen.
 Eject	This removes the USB device safely from the Host PC. The ejection operation is to ensure the operating system is not busy reading from or writing to the USB drive when you remove it, as this could result in corrupted data or a damaged drive.
 Shutdown	Clicking on this button performs an orderly system shutdown of the Host PC by closing all processes running and powering off the computer. Note: If you are using a version of Host Software before 5.01, you will need to press the power button of the host PC after

	running the system shutdown to power off the computer.
 Help	This brings up the help document.

4) Tree View –This panel contains the directory listing of the “ELCL” folder of the Host PC hard drive as well as any other drives attached to the Host PC (e.g., a USB flash drive). The following two folders are essential to the operation of the eye tracker: the “elcl\exe” folder, which contains the Host application that runs the eye tracker as well as the configuration files, and the “elcl\data” folder, which is where all of the EDF files created during the experiments are stored. The “elcl\data” folder also stores the log files for the recording sessions and screen grabs created by pressing ALT+F7 on the host keyboard, which can be used for troubleshooting purposes.

The Tree View panel allows users to navigate around different folders of the Host PC. The currently-selected folder is highlighted in a blue background color. The subfolders and files within the current folder are displayed on the Folder View panel on the right. Navigating around the tree can be accomplished either by using the mouse, or by using the following keys.

- UP and DOWN arrows: move up or down along the tree.
- LEFT ARROW: if the current selection is an open folder, it closes it; otherwise it moves up the list to the parent folder.
- RIGHT ARROW: if the current selection is a closed folder, it opens it; otherwise, it moves down to the first child folder if there is one.

Clicking the right mouse button displays actions supported on the currently selected folder (cut, copy, paste, delete, rename, download, eject) on a popup menu. Not all operations are supported for all folders. Clicking on the download button allows you to download all of the files and subfolders in the currently selected folder to the local computer (usually in the “Downloads” folder of the user account). Clicking on the Upload button allows you to upload files to the currently-selected folder of the Host PC. Neither the download nor upload operation is supported when the Web UI is running on the Host PC. If a USB drive is connected to the Host PC, this drive can be ejected by choosing the “Eject” option from the right-click popup menu.

The disk space of the current drive will be displayed if the mouse cursor is placed on the uppermost parent folder of the tree.

The Tree View panel can be shown or hidden by clicking on the “Show/Hide Tree View” button in the toolbar. The size of the Tree View/Folder View windows



can be adjusted by placing the mouse on top of the separation bar between the two panels. Once the resizing cursor shows up, drag the separation bar to the intended position.

5) Folder view – this shows a list of folders and files contained in the currently selected folder in the Tree View panel. The full path of the current folder is displayed on the navigation bar on the top of the panel; clicking on any of the parent nodes in this bar will update the content of the Folder View accordingly. The Folder view presently supports two viewing modes: Tiles view and Details view. Tiles view (default) displays the files and folders as icons with the file names printed underneath the icons. All of the files and folders are arranged alphabetically. The Details view lists the contents of the current folder and provides detailed information about the files, including name, type, size, and date modified. The latter can be used to sort the files and folders listed in the current folder. To change the view, click on the "View" button in the toolbar and choose either Tiles or Details.

Selecting files/subfolders in the Folder View can be easily done with the computer mouse. A subfolder can be opened by first selecting the folder icon and then double clicking on it – the content of the Folder View, navigation bar, and Tree View will be updated accordingly. You can also use the UP, DOWN, LEFT, and RIGHT keys to change the selection in the Tiles view or the UP and DOWN keys to change the selection in the Details views. If the files in the current view fill the entire screen (with a vertical scrolling bar displayed on the right side), pressing the HOME key or END key displays the items at the beginning or end of the list, respectively. Pressing the PAGE UP or PAGE DOWN key scrolls up or down in the selection list.

Multiple items can be selected by holding down the CTRL key and then clicking the left mouse button once on top of the target item; a second click will remove the item from the current selection. To select items which are next to each other, you may click on the first item, hold down the SHIFT key, and then click on the last item in the desired selection. In the Tiles view, items which are next to each other can also be selected by holding down the CTRL key and then using LEFT, RIGHT, UP, and DOWN keys. To select all files in the folder, click on the right mouse button and select “Select All Items” from the popup menu. All of the currently-selected items can be deselected by clicking on the “Deselect all items” option from the popup menu.

For the files/folders that are currently selected, a right mouse click on the item(s) displays a list of supported actions (e.g., cut, copy, paste, delete, rename, download, and eject). Not all operations are supported for all files/folders. These actions can also be performed by clicking on the appropriate buttons in the application toolbar.

6) Preview/Edit panel - When a single plain text file (e.g., a tracker configuration file or an eye tracker log file) or an image file is selected, its content will be displayed in the Preview panel at the bottom of the File Manager. The “Preview/Edit Panel” button on the toolbar toggles on/off the visibility of this panel. The Preview/Edit panel can be expanded to full screen by clicking on the  button on the title bar of the panel or be restored to the original size by clicking on the  button. The size of the panel can also be adjusted by placing the mouse cursor on the title bar of the panel until a hand cursor shows up. Hold down the mouse button to drag the title bar to the intended position.

The Preview/Edit panel has two tabs. The Preview tab displays the content of an image or text file, or header of an EDF file. If the text file is too large, only the initial portion of it will be viewable. The edit tab can be used to edit the contents of plain text files. This can be handy for modifying the contents of tracker configuration files (i.e., the .ini files in the “\elcl\exe” folder). In the edit panel, some commonly-used text editing keyboard shortcuts are supported:









CTRL A	Selects the entire text in the file and highlights the selection.
CTRL C	Copies the current selection to the clipboard.
CTRL V	Pastes the content of the clipboard into the current location.
CTRL X	Cuts text that is highlighted.
CTRL Z	Performs an undo
CTRL Y	Performs a redo.
DELETE	Deletes the current selection without storing it to the clipboard (and thus, you cannot use CTRL V to paste it back).

2.1.2 Configuration Tool

The Configuration Manager provides a list of utilities that allows users to configure some of the commonly used tracker settings and to update the host software. The Configuration Manager consists of the following components:

- 1) Titlebar – this displays “SR Research EyeLink Configuration”.
- 2) Browser URL –this is configured as <http://100.1.1.1/Configuration.html> by default. This URL depends on the IP address Host PC (100.1.1.1 is the default tracker address).
- 3) Toolbar – this contains a list of configuration utilities or buttons (e.g., to start the tracker and another to switch to the file manager). From left to right, the buttons on the toolbar are:

	Tracker	Clicking on this icon will start the Host application if the EyeLink 1000 Plus camera is properly powered up and connected.
---	---------	---

 File Manager	Switches to the File Manager interface for accessing files on the Host PC.
 Device Setting	Lists devices plugged to the Host PC (analog card, parallel port, button box) and allows users to configure the settings (e.g., disabling or enabling the device).
 Screen Setting	Allows you to configure settings that tell the eye tracker about physical characteristics of your setup that are important for proper visual angle and eye velocity calculations. Detailed instructions for updating the screen settings are provided in the EyeLink 1000 Plus Installation Guide.
 Network Setting	Reports the network card interfaces installed on the Host PC, with IP addresses and connection statuses displayed.
 System Time	Reports the current time of the Host PC and allows users to reset the computer time if necessary.
 System Update	Provides an interface to update or rollback the Host software. Detailed instructions are provided in the EyeLink 1000 Plus Installation Guide.
 Shutdown	Clicking on this button performs an orderly system shutdown of the Host PC by closing all processes running and powering off the computer. Note: If you are using a version of Host Software before 5.01, you will need to press the power button of the host PC after running the system shutdown to power off the computer.
 Help	This brings up the current document.

4) Configuring screen settings. To correctly compute visual angle, saccade amplitude, and eye velocity, the EyeLink 1000 Plus eye tracker needs to know the physical characteristics of your setup. Any time you change your physical configuration (for example, if a new monitor is used, if the eye-to-screen viewing distance is changed, etc.), you should use the Screen Settings configuration tool to ensure that the parameters accurately reflect your current setup. The first three parameters are important for all setups whereas the last parameter is important only for users of Remote Mode.

5) System Update - The EyeLink 1000 Plus host software installed on the tracker can be updated through the “System Update” tool. First download the latest version of the Host software from our support website <http://www.sr-support.com> (go to “Downloads -> EyeLink Host Software -> EyeLink 1000 Plus Host software”). Copy the file to a computer that runs the Web UI. Select the Update tab and click on the “Browse ...” button to locate the intended host software installer and then click “Update” button. Wait until the host software is updated – please be patient as this process may take a few minutes to complete.

2.1.3 Tracker Initialization Files

The Configuration tool described in the previous section and the “Set Options” screen in section 2.4.3 cover some of the most important settings for operating the eye tracker. However, there are some lower level options that can be specified by editing the configuration files (*.INI) or by sending commands from the Display PC via the Ethernet link. The configuration files are loaded by the EyeLink 1000 Plus eye tracker from the directory that contains the tracker program (\ELCL\EXE).

If you plan to make changes to the screen settings, please follow the instructions provided in the above “Configuration” tool (or section 8.4 “Customizing Screen Settings” of the EyeLink 1000 Plus Installation Guide). If you plan to change the default settings for other non-screen related settings, please copy and paste the target commands from the relevant .INI file to the FINAL.INI and make the modification in that file for ease of future maintenance. The file FINAL.INI will be the last configuration file to be processed by the tracker and thus override the settings listed in other .INI files. This design makes it easy to edit a single file to keep track of changes made, makes updating the software easy (just retain the settings in the FINAL.INI), and assists in troubleshooting.

This is a selective list of EyeLink configuration files, and what they control:

ANALOG.INI	-optional analog output hardware interface, configures clock/strobe control
BUTTONS.INI	-hardware definition of buttons, special button functions
CALIBR.INI	-commands used to control the calibration settings
COMMANDS.INI	-lists some useful EyeLink commands for controlling the host application via your own program
DATA.INI	-controls data written to EDF files, and the Ethernet link
DEFAULTS.INI	-default settings for all items in LASTRUN.INI: can be loaded from Setup menu
ELCL.INI	-contains commands specific to the EyeLink 1000 Plus series; includes other .INI files for specific mounts
AMTABLER.INI, ARTABLER.INI, BTABLEC.INI, BLRR.INI, BPRIMATE.INI,	-list of mount-specific configuration files

MLRR.INI, MPRIMATE.INI, MTABLEC.INI, RTABLEC.INI, and TOWER.INI	
EYENET.INI	-setup for Ethernet link: driver data, TCP/IP address
KEYS.INI	-special key function definitions, default user menus
LASTRUN.INI	-thresholds, menu choices etc. from the last session
PARSER.INI, REMPARSE.INI	-on-line parser data types, configuration, saccadic detection thresholds for the Remote (REMPARSER.INI) and non-Remote modes (PARSER.INI). SR RESEARCH STRONGLY RECOMMENDS YOU DO NOT MODIFY THESE FILES.
PHYSICAL.INI	-monitor and display resolution settings; all physical setup and simulation settings
VIDOVL.INI	-commands used to control the video overlay
FINAL.INI	-commands to be executed last (will override or change the state of other settings)

Table 1: EyeLink 1000 Plus Configuration Files

2.1.4 Running Web UI on a computer other than the host PC

The Host PC displays the Web UI interface when you close the Host application (by clicking on the “Exit EyeLink” button in the Offline screen or by pressing CTRL+Alt+Q keys together), or when there is an issue in starting the eye tracker. For some applications (e.g., downloading EDF and log files to the Display PC, editing the .ini files on the “\elcl\exe” folder or updating the host software), it might be easier and more convenient to run the Web UI on a different computer (typically the Display PC).

To run the Web UI interface on the Display PC, please make sure you have a network connection between the Display PC and the Host PC. On the Host PC, please plug the network port on the motherboard if you are using a Workstation Host PC, or to the USB-to-Ethernet converter if you are using a laptop as the Host PC. On the Display PC side, you need to configure the setting of the network port that is used for the connection – the IP address should be set to 100.1.1.2, the subnet mask should be set to 255.255.255.0, and all other fields

should be left blank. You can skip these steps if the display PC is already communicating with the eye tracker.

Now you can start a browser and type 100.1.1.1 in the address bar. The following browsers are supported:

- Firefox (version 20.0 or later)
- Google Chrome
- Internet Explorer (version 9.0 or later)
- Safari (version 5.0 or later).

2.2 Starting the Host Application

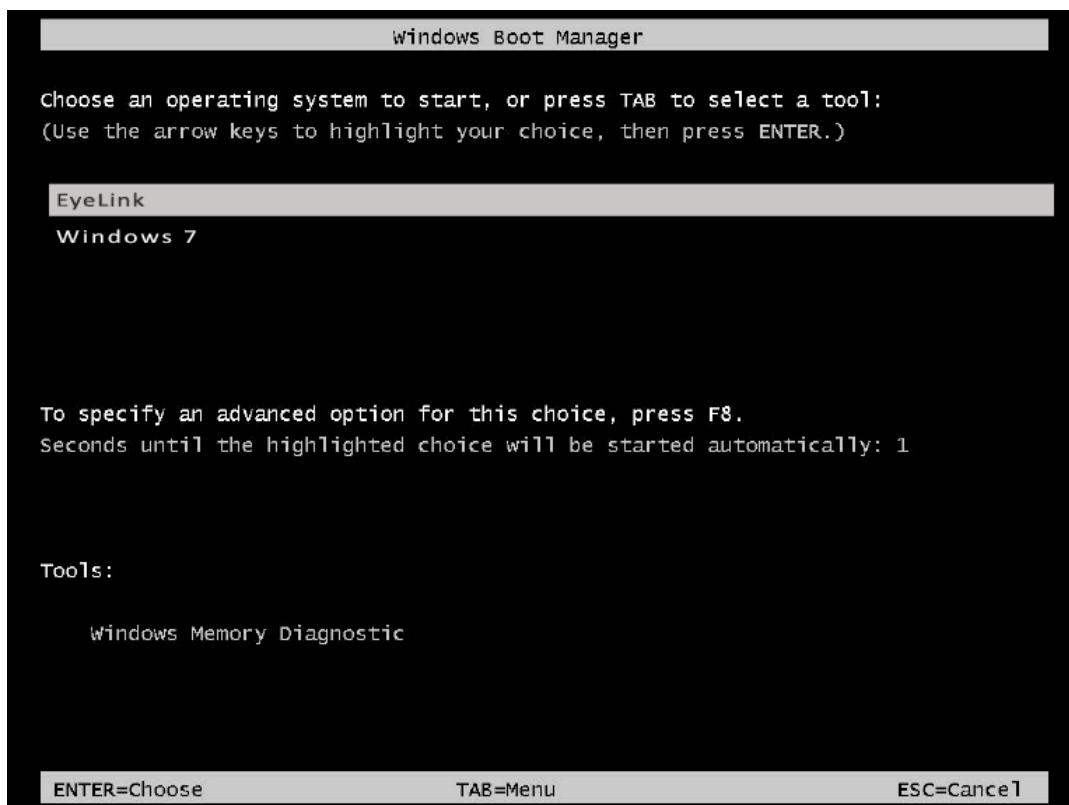



Figure 2-2: Booting into the EyeLink Partition

Make sure you have plugged in the power supply of the EyeLink 1000 Plus camera, and connected the camera to the correct Ethernet port on the Host PC using the network cable supplied with the system. Now turn on the Host PC. If your system shows the “Windows Boot Manager” interface, select the default “EyeLink” partition. The EyeLink 1000 Plus Host application will start

automatically. You will first see an EyeLink 1000 Plus splash screen, followed by the Camera Setup view of the Host application. Please make sure you are using the latest version of the EyeLink 1000 Plus Host software. The version of the Host software that is being used will be displayed on the Splash screen as well as on the lower right corner of the Offline screen. The latest Host software can be downloaded from the SR Research support website <http://www.sr-support.com> and can be installed using the System Update tool (see instructions in Section 8.1 “Host Software Update” of the EyeLink 1000 Plus Installation Guide).

From the Web UI interface, the Host application can be started by clicking on the tracker icon  from either the file manager or the configuration tool. In rare cases, you may find yourself at the command prompt of the QNX operating system. You can then either type **t** to restart the tracker application or **f** to go back to the file manager, or type **shutdown** to turn off the Host PC. To close the host application, press Ctrl-Alt-Q three-key combination on the host computer keyboard, or go to the Offline screen and click on the “Exit EyeLink” button. To turn off the Host PC, click the “Shutdown Host” button in the Offline screen of the Host application, or click the “Shutdown” button on the Web UI. If you are using a version of Host Software before 5.01, you will need to press the power button to turn off the host computer.

If the eye tracker fails to start, please watch closely for the error message that is displayed. The complete error message is written to the eye.log file in the “\elcl\data” folder and is retrievable through the File Manager. Consult section “8.2 Troubleshooting Instructions” of the EyeLink 1000 Plus Installation Guide for common troubleshooting tips. Click on the tracker icon on the file manager to restart the host application. If the problem persists, please contact support@sr-research.com.

2.3 Modes of Operation

The EyeLink 1000 Plus Host Software is designed to be used in two different operating modes:

Link: In Link mode, the eye tracker can be controlled by the Display PC via commands sent over the Ethernet link. The degree of Display PC control is dependent only on the display application itself. With appropriate programming, it is possible to have full control of the tracker via the Display PC. The SR Research Experiment Builder software and various low level programming interfaces have been designed to facilitate interacting with the Host PC. A common scenario is to have the application on the Display PC control the eye

tracker to start participant setup and calibration, while the operator uses the EyeLink Host PC's keyboard to remotely monitor and control data collection, perform drift correction, and handle problems if they occur.

Standalone: In Standalone mode, the eye tracker is an independent system, controlled by the operator via the Host PC tracker interface and keyboard. The Host PC may still be connected to a display-generating computer for the purpose of displaying calibration targets only. There are two possible data output modes when running the EyeLink 1000 Plus as a standalone system. These output modes are not mutually exclusive:

- a) Analog Output. Using the optional analog output card, data are available in analog format. Analog output options are configurable via the “Set Options” screen and in the ANALOG.INI file in the “elcl\exe” folder of the Host PC. Detailed operation instructions can be found in Chapter 7 of this manual.
- b) File Output. Eye data are available in the EyeLink EDF file format (see Chapter 4 “Data File”). This can be converted to an ASCII file using the EDF2ASC conversion utility or analyzed with EyeLink Data Viewer. Files can be manually created and closed via the “Output” Screen. File output options are configurable via the “Set Options” screen.

2.4 EyeLink 1000 Plus Host PC Navigation

The EyeLink 1000 Plus tracker interface consists of a set of setup and monitoring screens, which may be navigated by means of the Host PC mouse, key shortcuts, or from the Display PC application via link commands.

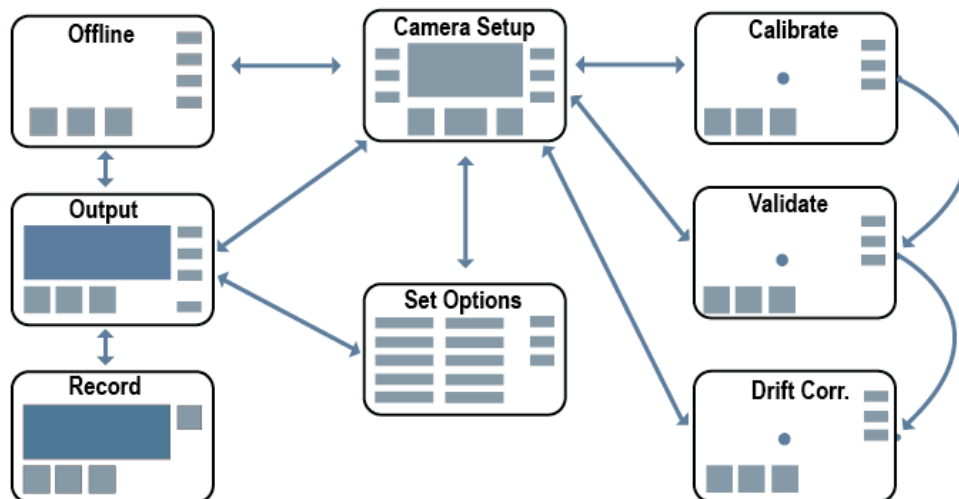

Figure 2-3: EyeLink 1000 Plus Host PC Application Overview

Each of the modes shown in Figure 2-3 has a special purpose. Where possible, each screen has a distinctive appearance. Menus of key options for navigation and setup are provided on the right-side of the screens. The thumbnail images of the eyes are displayed at the lower left corner of most screens and a status bar at the bottom. Arrows represent the navigations possible by key presses on the Host PC keyboard or via button selection using the Host PC mouse. All modes are accessible from the Display PC by link control. Note the central role of the Camera Setup menu.

The functions of each mode and the main access keys to other modes are summarized below. Pressing the on-screen Help button or hitting the F1 key will open a screen sensitive Help menu listing all available key shortcuts for that screen. From any screen, the key combination 'CTRL+ALT+Q' will exit the EyeLink Host Application.

2.4.1 Camera Setup Screen

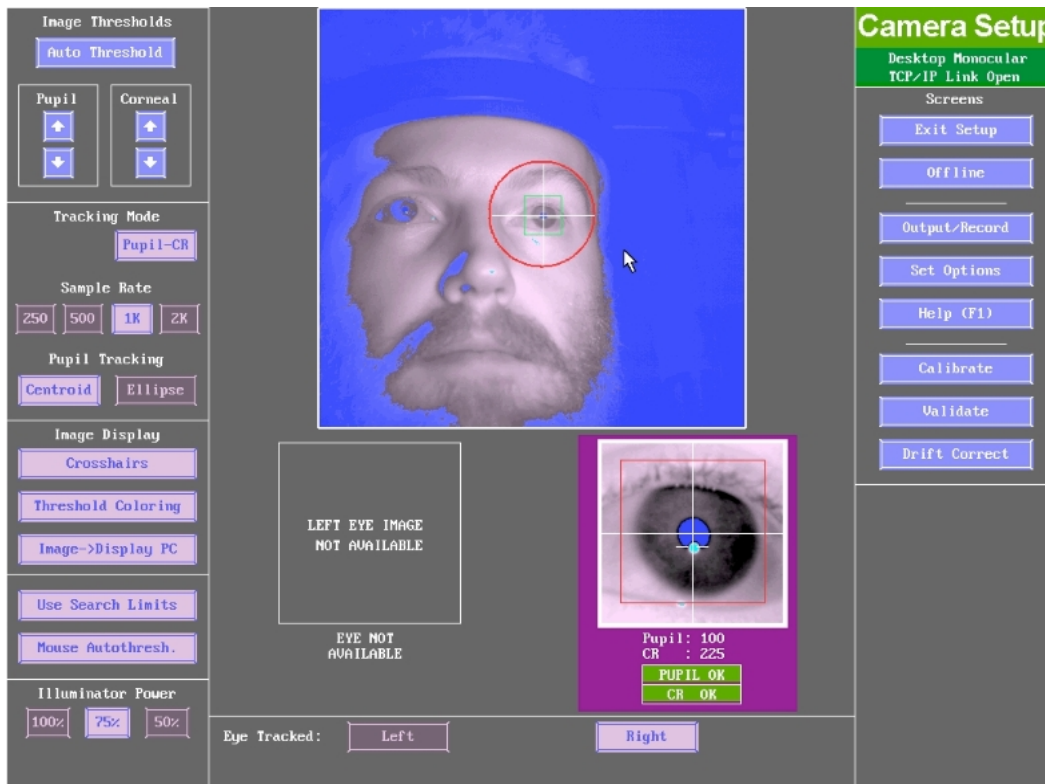

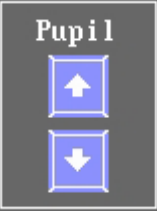

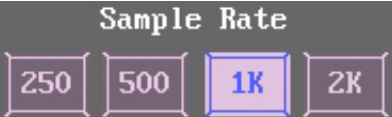

Figure 2-4: Example Camera Setup Screen

2.4.1.1 Camera Setup Screen Purpose

This is the central screen for most EyeLink 1000 Plus setup functions. From this screen, the view from the camera can be optimized and the pupil and corneal reflection (CR) detection threshold or biases can be established. The eye to be tracked, tracking mode, pupil-fitting model, search limits and display options can be set. Configuration of tracker settings, Calibration, Validation, and Drift Checking/Drift Correction can be initiated from this screen.

2.4.1.2 Camera Setup Screen Main Functions

	<p>Click to have the Host PC automatically compute the pupil and CR threshold levels. Fine tuning may be necessary. This button is not displayed when using the Remote Mode as the threshold levels are dynamically adjusted in this mode.</p>
<p>Keyboard Shortcuts: A = Auto Threshold selected image</p>	
	<p>Clicking these buttons manually increases or decreases the selected pupil threshold (or pupil threshold bias values for the Remote Mode).</p> <p>Keyboard Shortcuts: ↑ and ↓ increase and decrease pupil threshold/bias respectively</p>
	<p>In Pupil-CR mode, these buttons manually increase or decrease the selected CR threshold (or CR threshold bias for the Remote Mode).</p> <p>Keyboard Shortcuts: + and - increase and decrease CR threshold/bias respectively</p>
	<p>Select the tracking mode (pupil-only vs. pupil-CR) for recording. Typically, with most shipped systems, Pupil-CR is the only mode available because Pupil-only tracking requires complete head immobilization for high accuracy.</p>
<p>Keyboard Shortcuts: P = toggle Pupil only or Pupil-CR mode where possible</p>	
	<p>Select the sampling rate for recording. Here 1000 Hz is selected. The 2000 Hz sampling rate is available only with the 2000 Hz camera upgrade.</p>
<p>Keyboard Shortcuts: F = alternates Sample Rate selection</p>	

<p style="text-align: center;">Pupil Tracking</p> <div style="display: flex; justify-content: space-around;"> <div style="border: 1px solid black; padding: 2px; width: 40px; text-align: center;">Centroid</div> <div style="border: 1px solid black; padding: 2px; width: 40px; text-align: center;">Ellipse</div> </div>	<p>Select the method used to fit the pupil and determine pupil position.</p> <p>The Ellipse model is the only method available with the Remote Mode option.</p>
<p>Keyboard Shortcuts: Q = toggle selected pupil shape model</p>	<div style="border: 1px solid black; padding: 2px; text-align: center; width: 150px;">Crosshairs</div>
<p>Toggle display of pupil and CR crosshairs in camera images.</p>	<p>Keyboard Shortcuts: X = toggle crosshair display on/off</p>
<div style="border: 1px solid black; padding: 2px; text-align: center; width: 150px;">Threshold Coloring</div>	<p>Toggle display of threshold coloring in camera images. The coloring can be configured and is by default turquoise for the CR threshold and blue for pupil thresholds.</p>
<p>Keyboard Shortcuts: T = toggle threshold coloring in display</p>	<div style="border: 1px solid black; padding: 2px; text-align: center; width: 150px;">Image->Display PC</div>
<p>Select to present the camera display image on the Display PC monitor. This button will only be available when a display program is running on Display PC to control the eye tracker.</p>	<p>Keyboard Shortcuts: ENTER = toggle sending images over link</p>
<div style="border: 1px solid black; padding: 2px; text-align: center; width: 150px;">Use Search Limits</div>	<p>Indicate whether or not to use Search Limits (see Section 2.4.3 “Set Options” for a more comprehensive description). Search limits are always enabled in the Remote Mode.</p>
<p>Keyboard Shortcuts: U = Toggle search limit box on or off</p>	<div style="border: 1px solid black; padding: 2px; text-align: center; width: 150px;">Mouse Autothresh.</div>
<p>If selected, clicking on the pupil in the global image (Host or Display PC) tracks the pupil image at the clicked location, and performs an automatic threshold computation.</p>	<p>Keyboard Shortcuts: M = toggle Mouse-click Autothreshold on or off</p>
<div style="border: 1px solid black; padding: 2px; text-align: center; width: 150px;">Align Eye Window</div>	<p>If the eye is tracked, pressing the ‘Align Eye Window’ button will center the search limits box on the pupil position. This option is applicable in the Remote Mode only.</p>
<p>Keyboard Shortcuts: A = align the search limit box around eye position</p>	<div style="display: flex; justify-content: space-around; align-items: center;"> <div style="border: 1px solid black; padding: 2px; width: 40px; text-align: center;">100%</div> <div style="border: 1px solid black; padding: 2px; width: 40px; text-align: center;">75%</div> <div style="border: 1px solid black; padding: 2px; width: 40px; text-align: center;">50%</div> </div>
<p>Power level of the illuminators for the head-stabilized Desktop modes (100%, 75%, 50%) and the Remote Mode (100%, 75%).</p>	<p>Keyboard Shortcuts: I = change illuminator power level.</p>

EXP: 398=56% AUTO 1.00

Version 5.03 or later of the Host Software implements exposure control for the Remote Mode. If enabled (default behavior), the eye tracker will automatically adjust the exposure duration of the camera image frames so that the thresholds of the target and pupil are kept relatively constant. The exposure control status line reports the requested exposure duration and the corresponding fraction of the full exposure time to use, the status of the Auto/Manual exposure control, and the bias value (multiplier) of the auto exposure control.

Keyboard Shortcuts: CTRL + E = Toggle auto exposure on or off; CTRL + ↑ and ↓ = Adjust the bias value of auto exposure.



These two buttons, located just to the left and to the right of the global camera image, are available for use with Long Range and Primate Mount configurations to adjust the orientation of the displayed camera image. The left one is used to rotate the camera image in 90° steps and the right one is used to flip the camera image vertically.

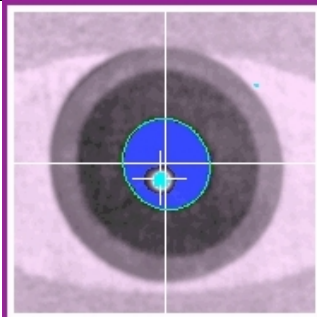

Pupil: 73
CR : 219

PUPIL OK
CR OK

Shows a zoomed-in image of the tracked eye. Pupil and CR thresholds and status are displayed beneath the camera image.

In the Remote Mode, bias values for pupil and CR thresholds are displayed.

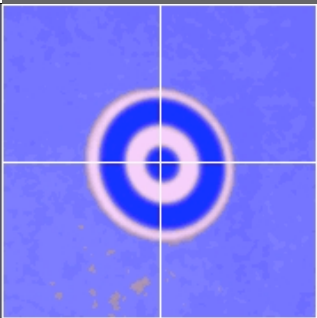

Target Thr : 185
Distance: 600.7 mm

TARGET OK
DIST OK

Shows the camera-target distance in millimeters and target threshold value (Remote Mode only).

Monocular-only Tower Mount and Primate Mount:



Binocular tracking in the Desktop Mount, Long-Range Mount, and Primate Mount:



Monocular tracking in the Desktop Mount, LCD Arm Mount, and Long-Range Mount:



Select the eye to track during recording. Here the Left eye is selected.

Monocular-only Tower Mount and Primate Mount: Clicking 'Camera Position Detect' polls the position of the camera selection knob indicating which eye is selected for tracking.

Desktop Mount (binocular): The 'Lock Tracked Eye' button disables the ability to switch the eye being tracked (as will pressing 'K').

Keyboard Shortcuts: B = track both eyes; R = track Right eye; L = track Left eye; E = cycle through eyes to track; K = auto detect camera position (Monocular-only Tower Mount and Primate Mount); toggle "Lock Tracked eye" button in binocular mode.



Click to return to the screen visited prior to the 'Camera Setup' screen.

Keyboard Shortcuts: ESC = exit 'Camera Setup'



Click to go to the 'Offline' screen.

Keyboard Shortcuts: ESC = go to 'Offline' screen



Click to go to the 'Output' screen, from which a Recording session can be conducted. This is most useful when using the EyeLink 1000 Plus in the standalone mode.

Keyboard Shortcuts: O = go to 'Output' screen



Click to go to the 'Set Options' screen

Keyboard Shortcuts: S = go to 'Set Options'

Help (F1)	Click Help (F1) to access the online help page for Camera Setup. All available key shortcuts are listed on the Help screen.
Keyboard Shortcuts: F1 = open Help screen	
Calibrate	Click to go to the 'Calibrate' screen. After setting up the camera and adjusting thresholds (for non-Remote modes) or biases (for the Remote Mode), you need to calibrate the system for proper gaze or HREF recording.
Keyboard Shortcuts: C = go to Calibrate screen	
Validate	Click 'Validate' to go to the Validate screen. Validation shows the experimenter the gaze position accuracy achieved by the current calibration fitting. Validation should be run <i>after</i> a calibration has been performed.
Keyboard Shortcuts: V = go to Validate screen	
Drift Check	or
Drift Correct	Click to go to the 'Drift Check' or 'Drift Correct' screen. A Drift Check/Correct is recommended before each trial to ensure that accuracy of the calibration parameters is maintained. Generally this is initiated via the application running on the Display PC.
Keyboard Shortcuts: D = go to Drift Check screen	
Video Setup	Click to go to the Video Setup screen. See "EyeLink Video Overlay Option User's Manual" for details. This button is will be displayed only if the "Enable Overlay" button is turned on in the Set Options screen. This is useful only if your system has been licensed for video overlay option.
Keyboard Shortcuts: W = Video overlay configuration.	

2.4.1.3 Camera Setup Screen Key Shortcuts

Key	Function
ESC	Go to the Offline screen or exit Camera Setup
ENTER	Toggles sending camera images over link to Display PC
C	Go to the Calibrate screen
V	Go to the Validate screen
D	Go to the Drift Check/Correct screen
O	Go to the Output screen
S	Go to Set Options page
F1	Open the Help dialog, which contains a brief overview of the role of this screen and the key functions for it
Ctrl + Alt + Q	Exit the EyeLink Host application
Page Up and ↑	Increase pupil threshold/bias

Page Down and ↓	Decrease pupil threshold/bias
+ and -	Set corneal reflection threshold/bias
← and →	Select Eye, and cycle through the Global or zoomed view for link
A	Auto threshold selected image (all non-Remote modes); For the Remote Mode, center the search limit box on top of the current eye position
E	Cycle through eye(s) to track.
L	Select left eye for recording
R	Select Right eye for recording
B	Select both eyes for recording
P	Toggle Pupil only or Pupil-CR mode selection (may be locked)
Q	Toggle Ellipse and Centroid pupil position algorithm
F	Select sampling rate of EyeLink recording
U	Toggle search limit box on or off
SHIFT and cursor keys (←, →, ↑, or ↓)	If search limits are enabled, these keys can be used to move the position of the search limits.
ALT and cursor keys (←, →, ↑, or ↓)	If search limits are enabled, use these keys on the Host PC keyboard to adjust the size and shape of the search limits. On the Display PC, use a combination of Ctrl and cursor keys instead.
M	Toggle Mouse-click Autothreshold on or off
X	Toggle crosshair display
T	Toggle threshold coloring display
I	Change illuminator power (Desktop Mount and Arm Mount only)
K	Perform camera position autodetect (Monocular-only Tower mount and Primate Mount); Toggle “Lock Tracked Eye” button (Binocular Modes).
CTRL + E	Toggle Auto Exposure on or off
CTRL and ↑, or ↓	Adjust bias value of Auto Exposure
Video Overlay Only	
W	Video overlay configuration.

2.4.2 Offline Screen

2.4.2.1 Offline Screen Purpose

The Offline screen puts the eye tracker into an idle mode, in which it waits for commands or key presses to enter it into a different mode. This screen also displays some useful information on software version, camera ID, and IP addresses of the network cards.

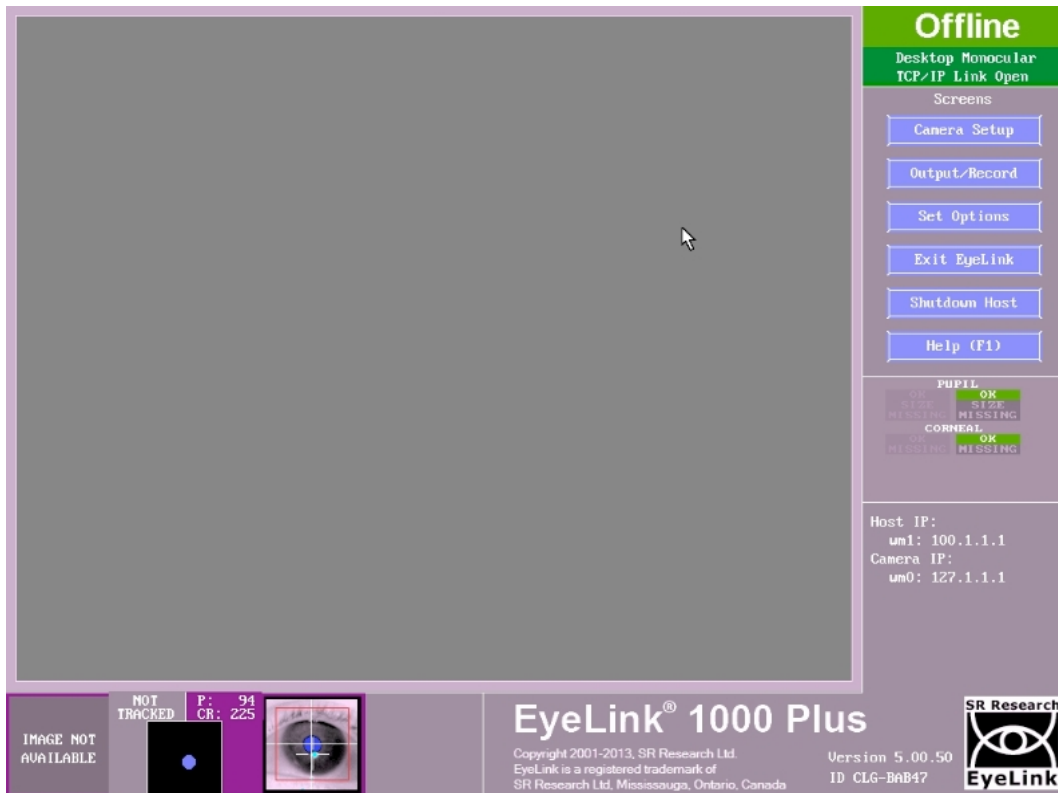







Figure 2-5: Example Offline Screen

2.4.2.2 Offline Screen Main Functions

	<p>Click to go to the ‘Camera Setup’ screen.</p>
<p>Keyboard Shortcuts: ENTER = ‘Camera Setup’</p>	
	<p>Click to go to the ‘Output’ screen, from which you can start a manual Recording session.</p>
<p>Keyboard Shortcuts: O = go to ‘Output’ screen</p>	
	<p>Click for access to a variety of EyeLink 1000 Plus options and settings on the ‘Set Options’ screen.</p>
<p>Keyboard Shortcuts: S = go to ‘Set Options’</p>	
	<p>Click to quit the EyeLink 1000 Plus Host PC application.</p>
<p>Keyboard Shortcuts: Ctrl + Alt + Q = Exit EyeLink</p>	
	<p>Click to perform an orderly system shutdown of the Host PC by closing all processes running and power off the Host PC (version 5.01 or later).</p>
<p>Keyboard Shortcuts: Ctrl + Alt + S = Shutdown Host</p>	

Help (F1)

Click to access the online help page for the 'Offline' screen. All available key shortcuts are also listed on the Help screen.

Keyboard Shortcuts: F1 = open Help screen

2.4.2.3 Offline Screen Key Shortcuts

ENTER	Go to the 'Camera Setup' screen
O	Go to the 'Output' screen
S	Go to the 'Set Options' screen
Ctrl + Alt + Q	Exit the EyeLink Host PC application
Ctrl + Alt + S	Shutdown the Host PC
F1	View the Help and key shortcuts for the 'Offline' screen

2.4.3 Set Options Screen

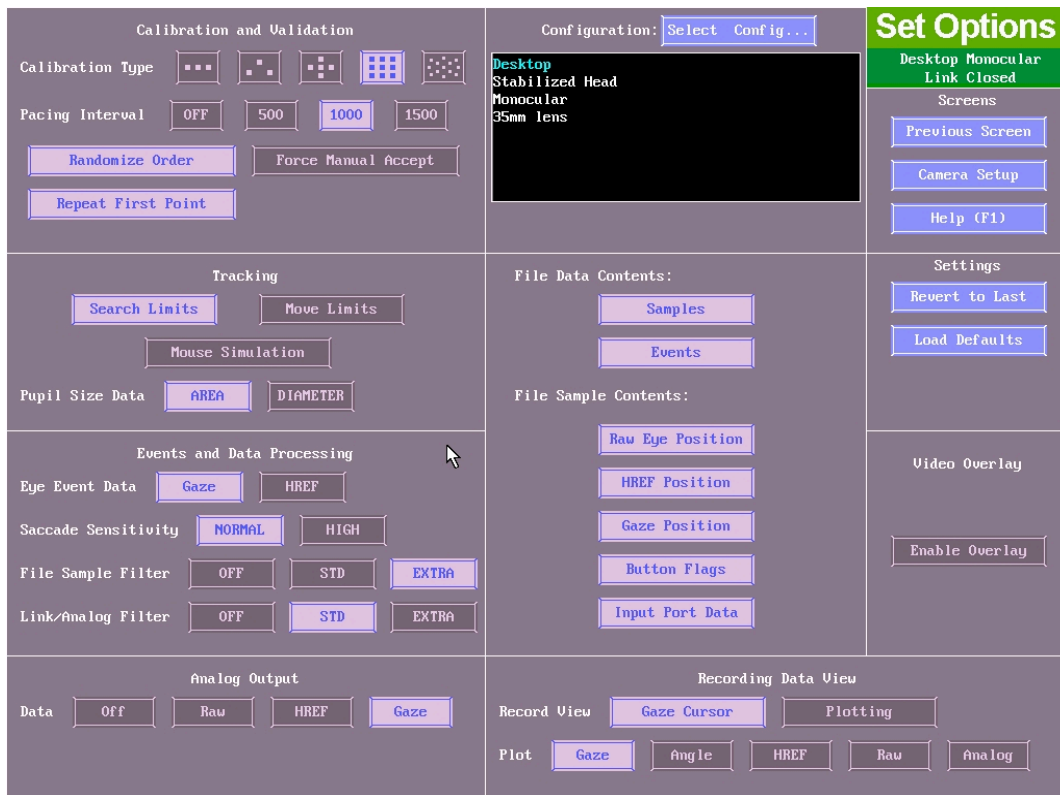

Figure 2-6: Example Set Options Screen













2.4.3.1 Set Options Screen Purpose

The Set Options screen allows many EyeLink 1000 Plus tracker options to be configured manually. This is useful when doing manual recording sessions in

standalone mode that are not driven by a Display PC using the EyeLink API, or to override or manipulate options not set by the Display PC application. Ideally, all settings to be crucially controlled are set by the Display PC application at runtime via a set of API calls.

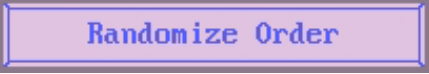
The Default Settings should be sufficient for many tracking applications.

2.4.3.2 Set Options Screen Main Functions

<p style="text-align: center;">Calibration and Validation</p> <p>Calibration Type     </p>	<p>Select the Calibration Type for recording. Generally speaking, the more locations sampled, the greater the accuracy that can be expected. While the 9-point calibration type is good for most tracking modes, we recommend using 13-point calibration type for the Remote Mode to get the best recording accuracy.</p>
<p>Keyboard Shortcuts: C=alternates between Calibration Type selected</p>	
<p>Pacing Interval    </p>	<p>Select the delay in milliseconds, between</p>
<p>successive calibration or validation targets if automatic target detection is active (Force Manual Accept is disabled).</p>	
<p>Keyboard Shortcuts: P = alternate between Pacing options</p>	
<p></p>	<p>Randomize the calibration and validation target presentation order.</p>
<p>Keyboard Shortcuts: R = toggle Randomize Order on/off</p>	
<p></p>	<p>Redisplay the first calibration or validation target at the end of the calibration sequence. As this is typically amongst the poorest samples obtained, toggling this option on is recommended.</p>
<p>Keyboard Shortcuts: 1 = toggle Repeat First Point on/off</p>	
<p></p>	<p>If enabled, manual pressing of the spacebar or ENTER key on Host or Display PC is required to gather the sample when the participant is looking at each calibration or validation target. If disabled, the calibration and validation procedure automatically samples a target fixation once the eye settles.</p>
<p>Keyboard Shortcuts: Y = toggle Force Manual Accept on/off.</p>	
<p></p>	<p>On the monocular-only Tower Mount, clicking the 'Camera Position Detect' button polls the position of the camera selection knob on the mount to determine which eye to track.</p>
<p>Keyboard Shortcuts: K = toggle camera eye autodetect on or off.</p>	

Lock Tracked Eye

This option is only applicable when performing a monocular recording in the binocular data collection modes. If this option is enabled, pressing the left or right cursor keys on the Display or Host keyboard will only cycle between the currently selected eye camera and the global view (so the other untracked eye is locked out). If this button is not enabled, pressing the left or right cursor key will cycle between the left, right, and global camera images and thus you may end up selecting the unintended eye.

Keyboard Shortcuts: K = Lock the currently selected Eye.

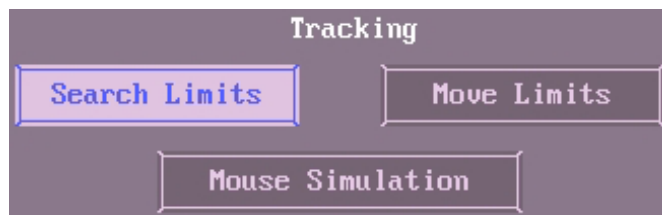

Search Limits are used to narrow down the area of the camera image to be searched for the pupil or CR. A red box or ellipse around the searched area appears in the Host PC's global view if this option is

enabled. Search Limits are useful for images with pupil or CR foils, such as reflections off of glasses or makeup.

If 'Search Limits' is enabled and the pupil position moves, search for the pupil is confined to the area within the red box; otherwise, the entire image is searched for the pupil.

If 'Move Limits' is checked, the search limit box moves along with the pupil.

Search Limits are automatically active with the Remote Mode.

In 'Mouse Simulation' mode, the Host PC mouse simulates eye movements and can be used for experiment testing and debugging purposes.

Keyboard Shortcuts: M = toggle on/off Mouse Simulation, F4 = toggle Search Limit on/off, F5 = toggle dynamic updating of the Search Limit area around the pupil

Pupil Size Data

AREA

DIAMETER

Record the pupil area or diameter. The area is recorded in scaled camera image pixels.

Diameter is calculated from pupil area fit using a circle model.

Keyboard Shortcuts: S = alternate between pupil Area or Diameter data

Eye Event Data

GAZE

HREF

Select whether to record eye events (fixations and saccades) in Gaze or HREF coordinate.

GAZE is screen gaze x, y; HREF is head referenced-calibrated x, y. See section 4.4.2 for description of the data types.

Keyboard Shortcuts: E = alternate between Gaze and HREF settings

Saccade Sensitivity

NORMAL

HIGH

Define the sensitivity of the EyeLink 1000 Plus parser for saccade event

generation. Normal is intended for cognitive tasks like reading; while High is intended for psychophysical tasks where small saccades must be detected. See Section 4.3.3 Saccadic Thresholds for details of event parsing.

Keyboard Shortcuts: X = alternate between Saccade Sensitivity levels

File Sample Filter

OFF

STD

EXTRA

EyeLink eye trackers

use a heuristic filtering algorithm for data smoothing. Data filtering can be applied independently for the data saved in the EDF file and for the data sent to link/analog output. The current option selects filter level of data recorded to the EDF file.

Each increase in filter level reduces noise by a factor of 2 to 3.

Keyboard Shortcuts: F2 = alternate between filter levels for the EDF file

Note: Data presented in EyeLink Data Viewer uses the File Sample Filter. SR Research Ltd recommends leaving this value set to EXTRA.

Link/Analog Filter

OFF

STD

EXTRA

Select the filter level for data available

via the Ethernet link and analog card output.

Each increase in filter level reduces noise by a factor of 2 to 3 but introduces a 1-sample delay to the link sample feed.

Keyboard Shortcuts: F3 = alternate between filter levels for the link

Analog Output

Data

Off

Raw

HREF

Gaze

Select the type of data for analog output. OFF turns off analog output;

RAW is uncalibrated pupil x, y in camera coordinates; HREF is head referenced-calibrated x, y; GAZE is screen gaze x, y.

This setting will only be available if the analog card is installed on the host computer and enabled in the Configuration tool (via "Configuration -> Devices").

Keyboard Shortcuts: A = alternate between analog output options

Configuration

Select Config...

Desktop

Stabilized Head

Binoc/Monoc

35mm lens

Select the tracker configuration. Each configuration option indicates the Camera Mount Type (Tower, Desktop, LCD Arm, Primate, Long Range Mount) and whether a monocular or binocular recording is performed. The Desktop and Arm mounts additionally support Remote Mode options (a camera upgrade for Remote Mode is required). Other entries in the descriptor include the recommended lens to use and reminders about conditions of recording (e.g., Stabilized Head, Target Sticker).

SET CONFIGURATION					
		Accept			Cancel
Desktop	Stabilized Head	Monocular	35mm lens	MTABLER	
Desktop	Stabilized Head	Binoc/Monoc	35mm lens	BTABLER	
Desktop (Remote mode)	Target Sticker	Monocular	16/25mm lens	RTABLER	
Desktop (Remote mode)	Target Sticker	Binoc/Monoc	16/25mm lens	RBTABLER	
Arm Mount	Stabilized Head	Monocular	35mm lens	AMTABLER	
Arm Mount (Remote mode)	Target Sticker	Monocular	16/25mm lens	ARTABLER	
Tower Mount (Binocular)	Stabilized Head	Binoc/Monoc	25mm lens	BTOWER	

Clicking on the 'Select Config' button raises the dialog box above, from which other configurations can be selected. Each column consists of the description entries and the last entry is a unique identifier for the configuration that will be logged in the EDF file.

Lens

16 mm

25 mm

Version 5.08 or later of the host software provides an additional Lens configuration after selecting one of the Remote modes. The remote mode by default is configured to use 16 mm lens. Some systems may also be supplied with a 25 mm remote lens (with a special marking on the focusing wheel). The 25 mm lens provides better recording data quality at the expense of a smaller head box; the 25 mm lens is recommended for 1000 Hz recording. Please make sure the lens selected in this configuration matches to the actual lens installed on the camera so that a proper target-to-camera distance can be reported by the host software.

For the Primate Mounts and monocular-only Tower Mount, the available configurations are shown below. Binocular recordings are supported in the Primate mount.

SET CONFIGURATION				
		Accept	Cancel	
Tower Mount	Stabilized Head	Monocular	25mm lens	TOWER
Primate Mount	Stabilized Head	Monocular	25mm lens	M PRIM
Primate Mount	Stabilized Head	Binoc/Monoc	25mm lens	B PRIM

The following shows the configurations available for the Long-Range mount.

SET CONFIGURATION					
		Accept	Cancel		
Long Range Mount	Stabilized Head	Monocular	35-75mm lenses	Camera Level	MLRR
Long Range Mount	Stabilized Head	Binoc/Monoc	35-75mm lenses	Camera Angled	BLRR

Keyboard Shortcuts: F8 = provide the dialog box with options; up and down cursor keys move selection among available configurations; Enter = accept the selection.

File Data Contents:

Samples

Events

Selecting 'Samples' will record data samples to the EDF file, and selecting Events will record on-line parsed events. These options are only useful for standalone recordings. If you collect data by running a display program, these settings will likely be overwritten by display commands.

Keyboard Shortcuts: F = alternate selection of Samples and Events buttons

Raw Eye Position

Record the raw (x, y) coordinate pairs from the camera to the EDF file. See section 4.4.2.1 for description of raw data type.

Keyboard Shortcuts: 3 = toggle record Raw Eye Position on/off

HREF Position

Record head-referenced eye-rotation angle (HREF) to the EDF file. See section 4.4.2.2 for description of HREF data type.

Keyboard Shortcuts: 4 = toggle record HREF Position on/off

Gaze Position









Record gaze position data in the EDF file. See section 4.4.2.3 for description of GAZE data type.

Keyboard Shortcuts: G = toggle Gaze Position record on/off

Button Flags

Record EyeLink button state and change flags, in the EDF file.

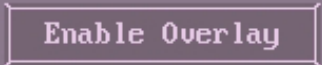
Keyboard Shortcuts: B = toggle Button Flags record on/off

	<p>Record external device data (from the parallel port or EyeLink Analog Card) on each sample, in the EDF file.</p>	
<p>Keyboard Shortcuts: I = toggle Input Port Data record on/off</p>		
	<p>Click to view previous screen.</p>	
<p>Keyboard Shortcuts: ESC= Previous Screen</p>		
	<p>Click to view Camera Setup screen.</p>	
<p>Keyboard Shortcuts: ENTER = Camera Setup</p>		
	<p>Click to access the online help page for Set Options screen. Keyboard shortcuts are listed on the Help screen.</p>	
<p>Keyboard Shortcuts: F1 = open Help screen</p>		
<p>Settings</p>	<p>Clicking 'Revert to Last' restores EyeLink settings to the values active at the beginning of the current session, which were also the settings active at the end of the last session.</p>	
		
	<p>Clicking 'Load Defaults' reverts to settings specified in the DEFAULTS.INI file.</p>	
<p>Keyboard Shortcuts: L= Revert to Last configuration; D= Load Defaults</p>		
<p>Video Overlay</p>	<p>Clicking 'Enable Overlay' activates the video overlay option.</p>	
	<p>Clicking 'Video Setup' goes to the Video Setup screen.</p>	
	<p>Keyboard Shortcuts: O= toggle video overlay on/off; V= click to view the Video Setup screen.</p>	
		<p>These settings control what to show on the</p>
<p>Record screen during data output. If Record View is set to Gaze Cursor, the Host PC Record screen will display the participant's current gaze position as a cursor overlaid on a simulated display screen. If Record View is set to Plotting, x, y data traces will be graphed as a function of time. The user can further select which data type should be plotted. See Section 0 for description of the record screen and plot view.</p>		
<p>Keyboard Shortcuts: F6 = select view to show on the Record screen (Plot or Gaze Cursor view); F7 = select the type of data to display in Plot view.</p>		

2.4.3.3 Set Options Screen Key Shortcuts

Key	Function
C	Calibration Type selected
P	Pacing Interval (for automatic calibration and validation target sequence presentation)
R	Randomize calibration and validation target order
Y	Enable manual calibration
1	Repeat First Point of calibration
K	Autodetect the eye to be track (Mirror Mount) Lock the currently selected eye (tracking eye monocularly in a binocular setup)
F4	Toggle search limit box on/off
F5	Toggle if search limit box follows pupil
M	Mouse simulation of eye
S	Pupil size type
F8	Choose the appropriate mount type
E	Eye event data (to saccade detector)
X	Saccade detector sensitivity
F2	File sample data filter level
F3	Link/Analog data filter level
F	File data contents selection
3	Raw eye position in samples
4	HREF eye position in samples
G	Gaze position and resolution in samples
B	Button samples should be recorded
I	Input Port data in samples
A	Analog output data selection
V	Select to view video setup screen, if the overlay option is enabled.
O	Toggle on/off video overlay option.
F6	Select record view (plot or gaze cursor).
F7	Select record plot data type.
ENTER	Camera Setup screen
ESC	Return to previous screen
F1	HELP screen
L	Revert to configuration from last session. This is still saved even when the PC is turned off.
D	Load default configuration (DEFAULTS.INI)

2.4.3.4 Lens Guide for Different Viewing Distances

The EyeLink 1000 Plus eye tracker has a versatile camera that can be fit with different lenses to accommodate different eye-to-camera distances. The table below indicates recommended lenses for different mounts and distances. The lens is one consideration in determining suitability of a particular mount for an eye tracking application, but the illumination source and intensity at different distances is also a major consideration.

The eye tracker may work with other lens-distance combinations not listed here, but this has not been extensively tested and may not work for all participants. When deviating from the above recommendations, it is incumbent on the researcher to ensure that the system is set up so there is suitable illumination, and a good view of the eye(s) to be tracked.

Lens Aperture Size	Tower/ Primate Mount	Desktop Mount or LCD Arm Mount		Long Range Mount
		with Head Support	Remote Mode	Monocular/Binocular
16 mm (Short Handle or Focusing Ring)	-	-	50-70 cm	-
25 mm (Large wheel with Special Marking)	-	-	50-70 cm	-
25 mm (Long Handle or Large Wheel)	IDEAL	-	-	-
35 mm	-	50-70 cm	-	60-70 cm
50 mm	-	-	-	70-100 cm
75 mm	-	-	-	100-150 cm

Table 2: Lens Guide for Different Viewing Distances

2.4.4 Calibrate Screen

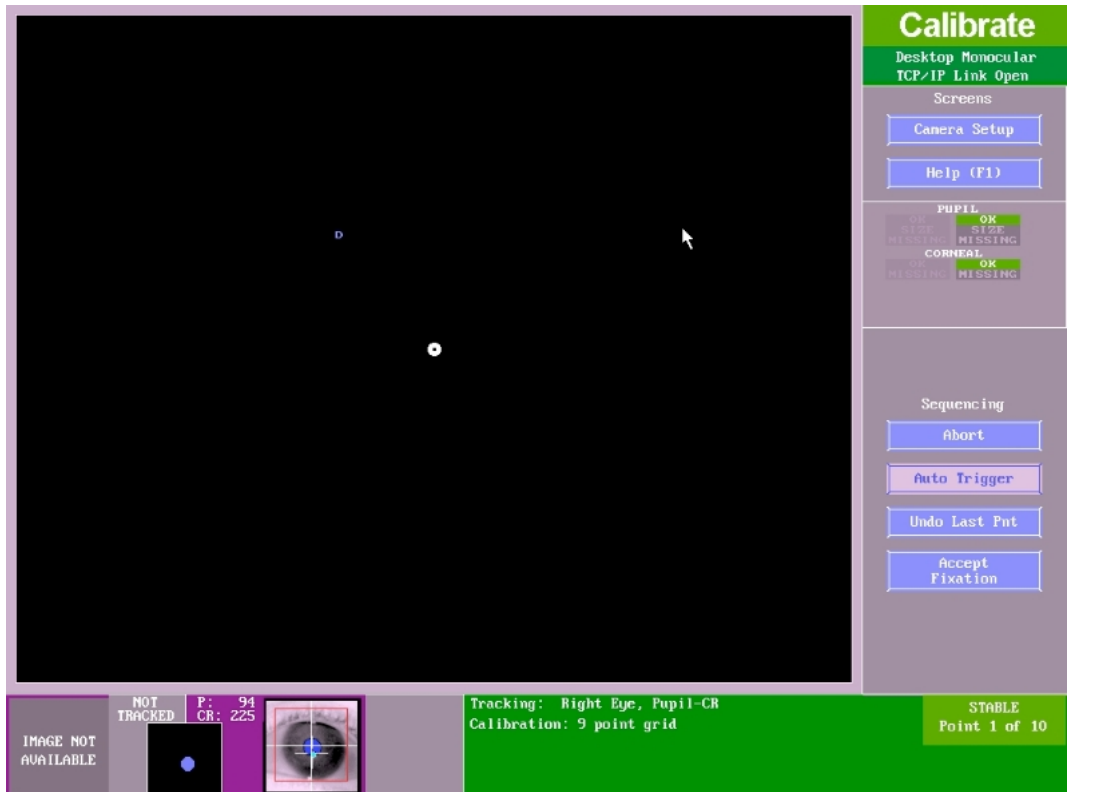

Figure 2-7: Example Calibrate Screen



2.4.4.1 Calibrate Screen Purpose

Calibration is used to collect fixation samples from known target points in order to map raw eye data to either gaze position or HREF data. Targets are serially presented by the Display PC. The participant fixates each while samples are collected and feedback graphics are presented on the Host PC display. The calibration is automatically checked when finished, and diagnostics are provided. Calibration should be performed after Camera Setup and before Validation. Validation provides the experimenter with information about calibration accuracy.

The zoomed and global views of the camera image, along with pupil and CR threshold values, are displayed at the bottom left of the screen. The eye to be calibrated as well as the calibration type (as defined in the Set Options screen or via the EyeLink API) is indicated beside the camera images at the bottom of the screen. The calibration status and calibration target currently being presented are indicated at the bottom right of the screen.

To perform a calibration, have the participant look at the first fixation point and select the 'Accept Fixation' button, or press the ENTER key or the Spacebar, to start the calibration. For subsequent targets, fixations can be accepted either automatically by the host application, or manually by the experimenter. If 'Auto Trigger' button is disabled ('Force Manual Accept' from the Set Options screen is enabled), you will need to manually accept fixation for each of the calibration targets. Pressing the ENTER key or the Spacebar after accepting the first target will switch from an automatic calibration to a manual calibration in which all remaining target fixations must be manually accepted. This can be useful for participants who have difficulty fixating targets or who inappropriately anticipate new target positions. The '<- Backspace' key can be used to undo the most recently accepted fixation target (e.g., if a participant fixates the wrong target position or anticipate the new target position). Pressing this key will successively remove acquired samples and present the calibration targets again. This allows the operator the ability to intervene when the acquired samples may be erroneous.

2.4.4.2 Calibrate Screen Main Functions

	Click to go back to the 'Camera Setup' screen. Keyboard Shortcuts: ESC = 'Camera Setup'
	Click to see Help and keyboard shortcuts. Keyboard Shortcuts: F1 = Help screen

Abort	Terminate Calibration sequence. Keyboard Shortcuts: ESC = Abort
Restart	Restart the Calibration
Auto Trigger	Click to automate the calibration sequence according to the Pacing Interval from the 'Set Options' screen. Keyboard Shortcuts: A = Auto Trigger
Undo Last Pnt	Click to repeat the last calibration target or last few targets. Keyboard Shortcuts: Backspace = undo last few targets
Accept Fixation	Press to accept fixation value, after the participant's gaze is stable on the target. Keyboard Shortcuts: ENTER, Spacebar = 'Accept Fixation'

2.4.4.3 Calibrate Screen Key Shortcuts

Key	Function
F1	Help screen
ESC	Camera setup
A	Automatic calibration set to the pacing interval selected in Set Options menu. (Auto trigger ON). EyeLink accepts current fixation if it is stable.
During Calibration	
ENTER or Spacebar	Begin calibration sequence or accepts calibration value given. After first point, also selects manual calibration mode.
ESC	Terminate calibration sequence.
M	Manual calibration (Auto trigger turned off.)
A	Automatic calibration set to the pacing selected in Set Options menu. (Auto trigger ON). EyeLink accepts current fixation if it is stable.
Backspace	Repeat previous calibration targets.
After Calibration	
F1	Help screen
ENTER	Accept calibration values
V	Validate calibration values
ESC	Discard calibration values
Backspace	Repeat last calibration target.

2.4.5 Validate Screen

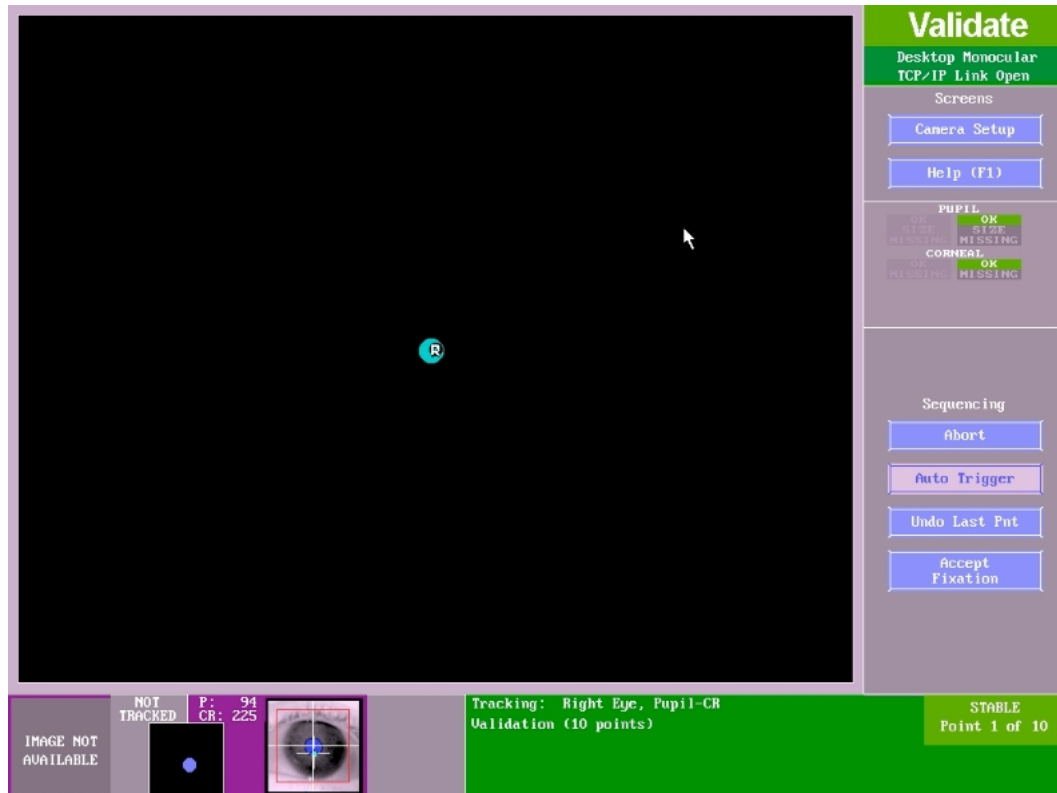

Figure 2-8: Example Validate Screen

2.4.5.1 Validate Screen Purpose







The Validate screen displays target positions to the participant and measures the difference between the target position and the computed fixation position for the target based on the calibration model. Spatial error is reported in degrees of visual angle, and can reflect both the adequacy of the initial calibration model, and the participant's ability to refixate the targets during validation. The functionality available in the Validate screen is very similar to that of the Calibrate screen.

Validation should only be performed after Calibration.

To perform a validation, have the participant look at the first fixation point and press the 'Accept Fixation' button, or the ENTER or Spacebar key, to start the validation. If 'Auto Trigger' is not enabled, you'll need to accept the target fixation manually.

If the accuracy at a fixated position is not acceptable, you may choose to perform a Calibration again and then recheck fixation accuracy by revalidating.

2.4.5.2 Validate Screen Main Functions

	Click to go to the 'Camera Setup' screen. Keyboard Shortcuts: ESC = 'Camera Setup'
	Click to view the help menu for the 'Validate' screen Keyboard Shortcuts: F1 = Help
	Click to terminate the validation process and revert to the camera setup screen. Keyboard Shortcuts: ESC = Abort the validation process
	Click to restart the validation process Keyboard Shortcuts: DELETE = restart Validation
	Click to automate the validation sequence according to the Pacing Interval from the 'Set Options' screen. Keyboard Shortcuts: A = Auto Trigger
	Press to accept fixation after the participant's gaze is stable on the target. Keyboard Shortcuts: ENTER, Spacebar = 'Accept Fixation'

2.4.5.3 Validate Screen Key Shortcuts

Key	Function
F1	Help screen
ESC	Terminate validation and go back to camera setup
A	Automatic validation set to the pacing selected in Set Options menu. (Auto trigger ON). EyeLink accepts current fixation if it is stable.
During Validation	
ESC	(First Point) Exit to Camera Setup (Following Points) Restart Validation.
F1	Help screen
ENTER or Spacebar	Begin validation sequence or accepts fixation on the target if the eye is stable. After first point, also selects manual validation mode.
M	Manual validation (Auto trigger turned off.)
A	Auto validation set to the pacing interval selected in Set Options menu. (Auto trigger ON). EyeLink accepts current fixation if it is stable.
Backspace	Repeat previous validation target(s).
After Validation	
F1	Help screen
ENTER	Accept validation values
ESC	Discard the current validation and switch to camera setup screen.
DELETE	Restart validation.

2.4.6 Drift Check/Drift Correct Screen

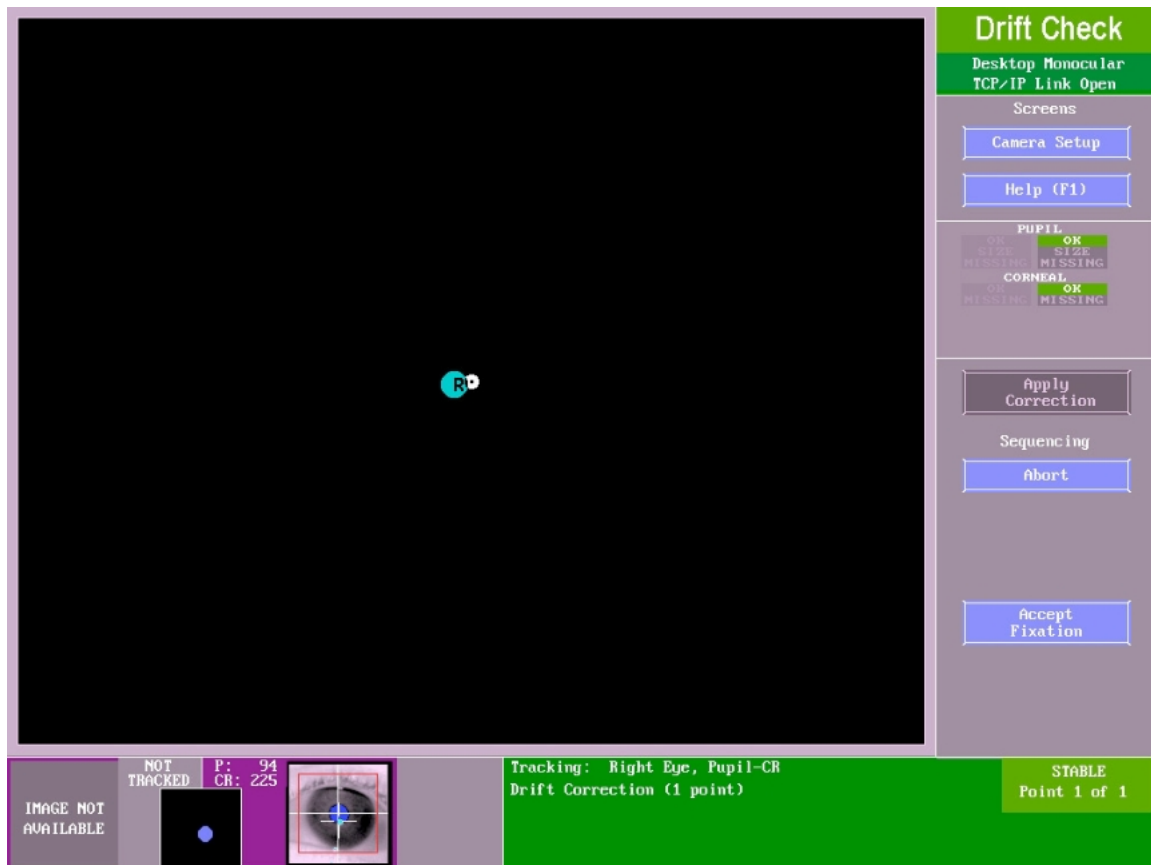

Figure 2-9: Example Drift Check/Drift Correct Screen

2.4.6.1 Drift Check/Drift Correct Screen Purpose





The Drift Check/Drift Correct screen displays a single target to the participant and then measures the difference between the computed fixation position and the current target. For EyeLink 1000 Plus, the default configuration leaves the calibration model unmodified. The purpose therefore, is to check whether the model has become grossly invalidated. If the error is large, the experimenter is prompted to acquire another sample. If the error remains large (i.e., the prior sampling error was reproduced), the drift check will fail and another calibration will be required (see Section 3.11 for more details).

To perform a drift check/correction, have the participant look at the first fixation point and click the 'Accept Fixation' button, or press ENTER or the Spacebar, to evaluate the adequacy of the calibration parameters.

Important: In EyeLink I and II systems, the fixation error calculated during drift correction was used to shift the calibration map. This linear adjustment often greatly improved the overall accuracy for upcoming recording. However,

with the EyeLink 1000 Plus eye tracker, the default behavior in the pupil-CR mode is to report the calculated fixation error without altering the calibration map in any way. Therefore the procedure is better viewed as a “Drift Checking” procedure in the EyeLink 1000 Plus, though a true Drift Correction can be easily enabled (by toggling on the “Apply Correction” button after entering in the Drift Check screen; see also section 3.11).

2.4.6.2 Drift Check/Drift Correct Screen Main Functions

	<p>Click to go to the ‘Camera Setup’ screen. Keyboard Shortcuts: ESC = exit to Camera Setup screen</p>
	<p>Click to view Help. Keyboard Shortcuts: F1 = Help</p>
	<p>Whether a correction will be applied to the calibration mapping. If “Apply Correction” is toggled on, a true drift correction will be performed; otherwise, the tracker just reports the error without correcting for it. Keyboard Shortcuts: D = Toggles on/off the “Apply Correction” button.</p>
	<p>Click to terminate the Drift Correct/Drift Check and exit to the Camera Setup screen.</p>
	<p>Press to accept fixation value, after the participant’s gaze is stable on the target. Keyboard Shortcuts: ENTER, Spacebar = ‘Accept Fixation’</p>

2.4.6.3 Drift Check/Drift Correct Screen Key Shortcuts

Key	Function
ENTER or Spacebar	Accept the fixation on the target.
ESC	Terminate the drift correct/drift check process and exits to camera setup screen.
D	Toggle on/off the “Apply Correction” button.
F1	Help screen

2.4.7 Output Screen

2.4.7.1 Output Screen Purpose

The Output screen is used to manually track and record eye movement data. EDF files may be opened and messages added, or data may be output via the

optional Analog output card. Data file contents are controlled from the Set Options screen.

Recording may be manually started from the Output screen, or by an application via the Ethernet link. Manual recording may be terminated by switching back to the OUTPUT screen. Be sure to close the data file before closing the tracker application.

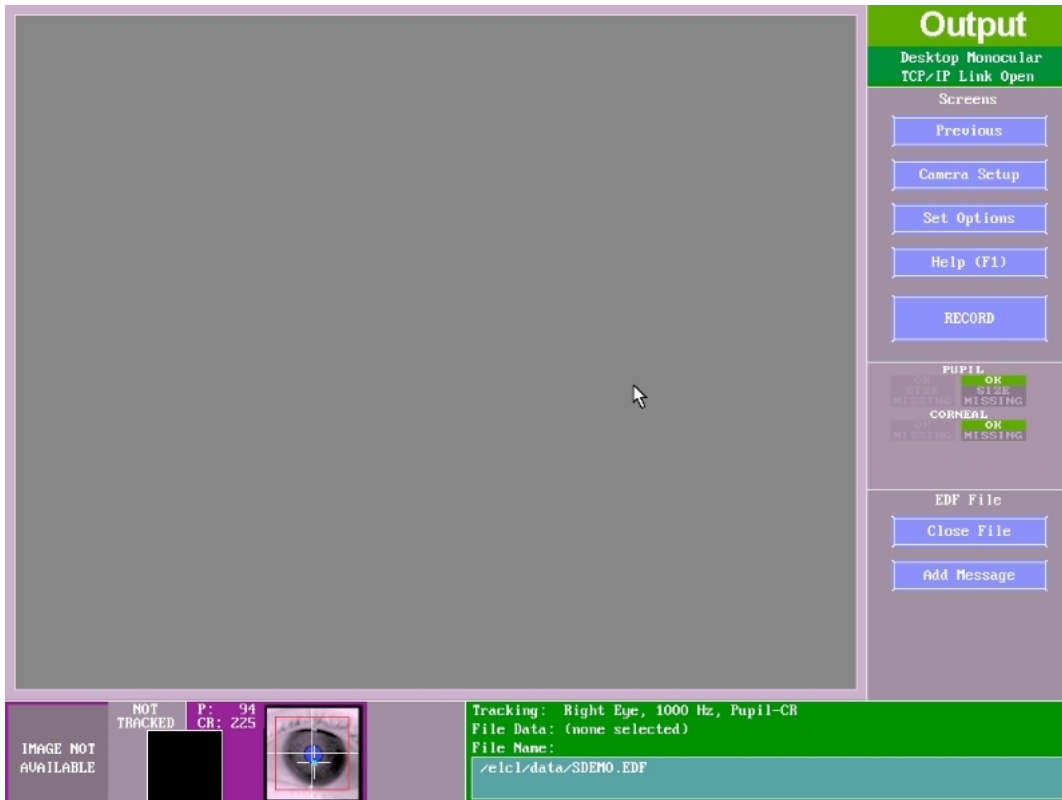









Figure 2-10: Example EyeLink 1000 Plus Output Screen

2.4.7.2 Output Screen Main Functions

	Click to go to the Previous screen
	Click to go to the 'Camera Setup' screen Keyboard Shortcuts: ESC = exit to 'Camera Setup' screen
	Click to go to the 'Set Options' screen Keyboard Shortcuts: S = go to 'Set Options' screen

	Click to access the online Help page for 'Camera Setup' Keyboard Shortcuts: F1 = open Help screen
	Click to begin recording data to an open EDF file Keyboard Shortcuts: ENTER or O = Record
	Click to open a data file for data recording and closes any open file. Keyboard Shortcuts: F = Open File
	Close the currently open EDF file Keyboard Shortcuts: X = Close File
	Add a message to the EDF file Keyboard Shortcuts: M = insert a message in the current file

2.4.7.3 Output Screen Key Shortcuts

Key	Function
ESC	Camera Setup Screen
ENTER or O	Start recording
S	Set options screen
F1	Help screen
F	Open EDF File (closes any open file)
X	Close EDF File
M	Add a message to the EDF file.

2.4.8 Record Screen

2.4.8.1 Record Screen Purpose

The Record screen allows users to initiate and observe data collection. The user can choose either a Gaze Cursor View (see Figure 2-11) or Plot View (see Figure 2-12) of the Record screen by toggling the "Plot View" button, or by pressing G.

The Gaze Cursor View plots the current gaze position of the participant in calibrated screen pixel coordinates. Any graphics drawn on the idle-mode screen are re-displayed on the screen to be used as a reference for the real-time gaze-position cursor. The gaze cursor view is only useful when the EyeLink system's built-in calibration routines have been used for gaze position calculation.

The Plot View displays the x, y data traces as a function of time. The type of data to be plotted can be configured at the Set Options screen. Since raw data can also be displayed in the plot view, this view can be useful in any data output mode, even when calibration has not been performed.

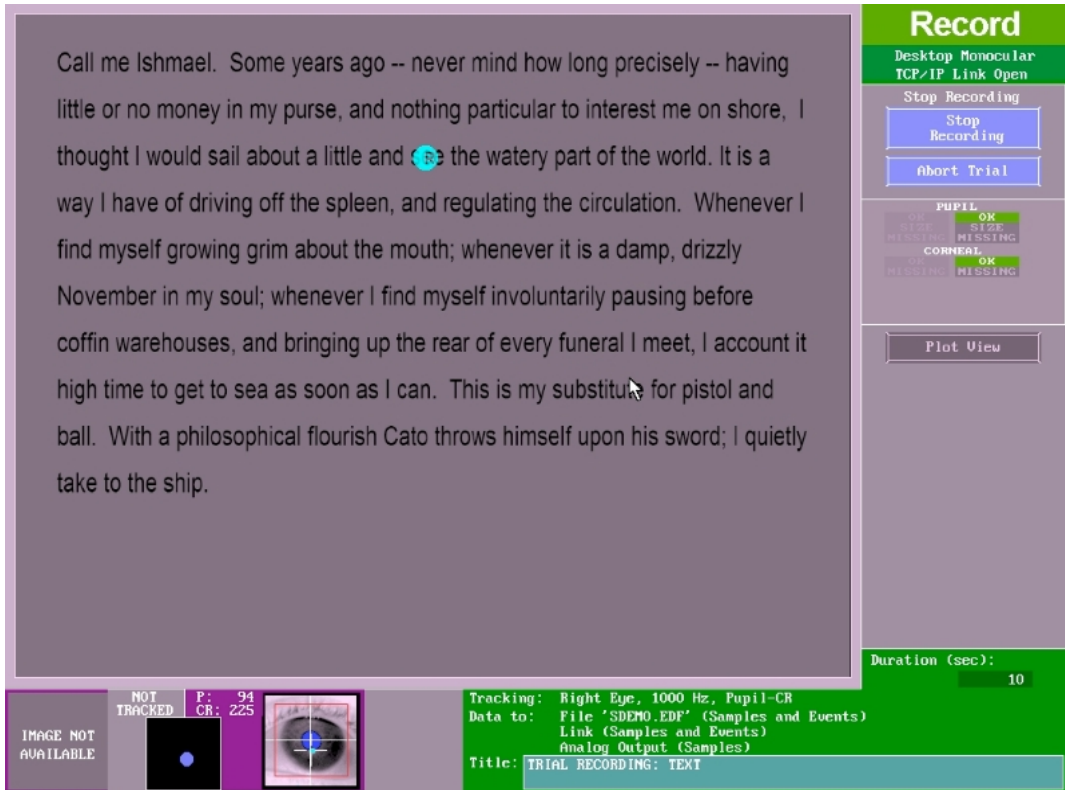

Figure 2-11: Example Record Screen (Gaze Cursor View)

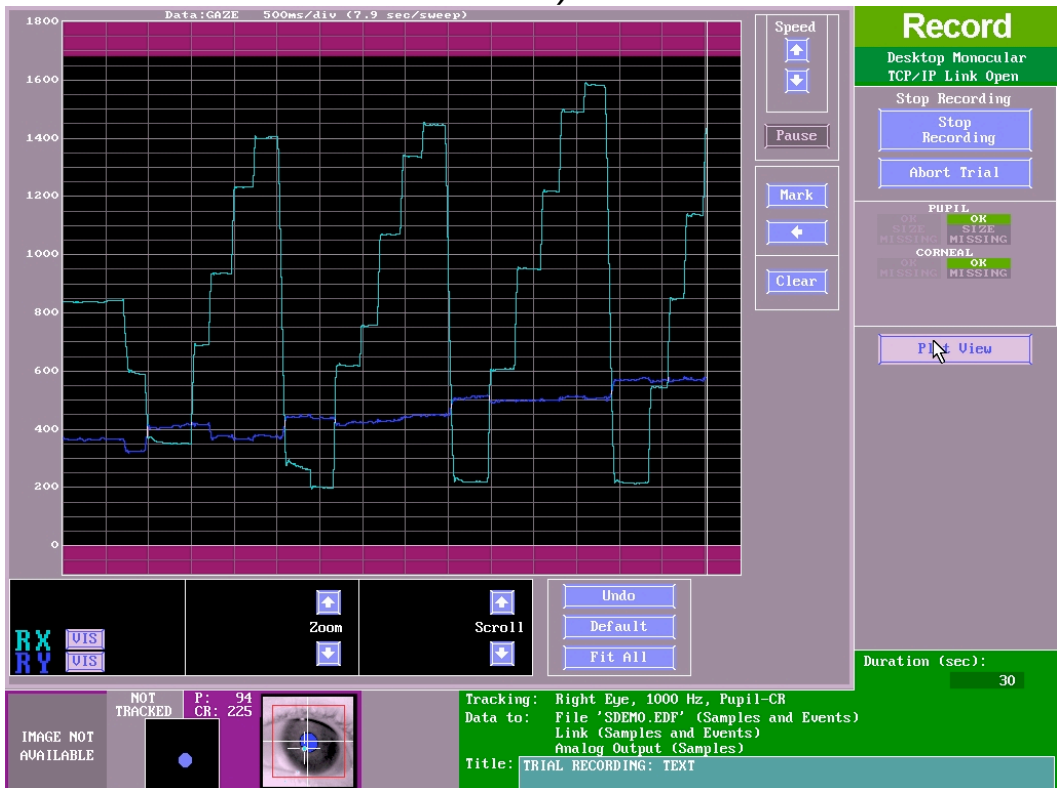





Figure 2-12: Example Record Screen (Plot View)

2.4.8.2 Record Screen Main Functions (Gaze View and Plot View)

	Stop the recording of data to the EDF file. Keyboard Shortcuts: ESC = Stop Recording
	Abort the trial recording (requires API applications). Keyboard Shortcuts: CTRL + ALT + A = Abort Trial
	If enabled, plot the x, y eye data being acquired as a function of time. Keyboard Shortcuts: G = toggle between Gaze Cursor and Plot Views

2.4.8.3 Buttons Used in the Plot View

The top of the Plot View shows the data type being plotted. The “Gaze” option plots the participant's gaze position in pixel (x, y) display coordinates. The “Angle” option plots the amount of x, y eye angle in degrees relative to the center of the screen. The “HREF” option plots eye rotation angles relative to the head in HREF coordinate (see Section 4.4.2.2 “HREF”). The “Raw” option plots the raw (x, y) coordinate pairs from the camera. The “Analog” option plots the x, y coordinate in voltages as done with the analog card output. The top-right lists the speed of plotting (i.e., amount of data being plotted in each screen). Figure 2-13 provides an example recording screen with a plotting speed of 7.9-seconds per sweep (each horizontal division represents 500-ms worth of data).

The vertical scale used in the plot view is dependent on the data type (Raw, Angle, HREF, Gaze, or Analog) set in the “Set Options” screen. For example, when plotting raw eye position, the data are within a range between -30000 and +30000. The two purple bands at the top and bottom portions of the display represent data that is out of normal range.





The visibility of the x and y eye traces can be controlled by the “VIS” buttons at the lower-right corner of the plot view.





For calibrated data types (GAZE, HREF, and Angle), the user can change the layout of the plot by clicking on the “zoom” and “scroll” buttons. The scale of the plotting can be changed by clicking on the ↑ and ↓ buttons in the “Zoom” section so that fine details or global patterns of the x, y traces can be viewed. The position where the traces are displayed can be changed by clicking on the ↑ and ↓ buttons in the “Scroll” section.

For Raw and analog outputs, the user can adjust the “gain” and “offset” to “calibrate” data during recording. This might be useful for experiments with primates or patients where the 9 point calibration method is not possible. Please note that, the additional buttons and gain/offset values are only available when the recording data type is set to “Raw” or “Analog”. The “ADJ” button for each of the eye traces can be turned on or off. For the ease of adjustments, user may select one eye trace at a time. The gain and offset adjustments can be done by using the ↑ and ↓ buttons in the “Gain” and

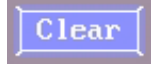
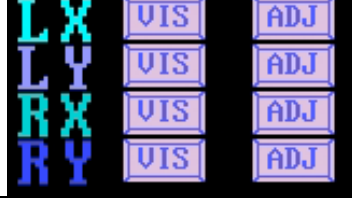
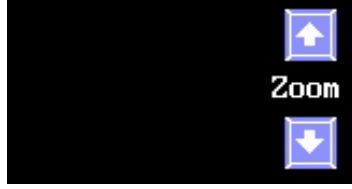
“Offset” sections. If you prefer to use mouse, gain can be adjusted by placing the mouse cursor outside of the region bound by a white bar to the right of the plot and dragging the mouse up (increasing the gain) or down (decreasing the gain). The offset can be adjusted by placing the mouse cursor inside of the region bound by a white bar to the right of the plot and dragging the mouse up (increasing the offset) or down (decreasing the offset). The current gain/offset settings can be saved into a file (*.pre) and reloaded later.

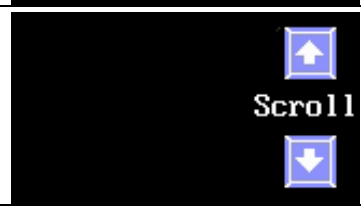
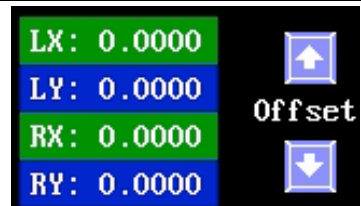
For all eye data types, the user can click on the “Undo” button to undo the last adjustment and on the “Default” button to load the default settings.

	<p>Set the amount (from 2.6 seconds to 79.2 seconds per sweep) of data to be plotted on each screen.</p> <p>Keyboard Shortcuts: < and > = change plot speed</p>
	<p>Stop or restart data plotting (the eye tracker continues recording despite that the plot view stops screen updating).</p> <p>Keyboard Shortcuts: P = pause data plotting</p>
	<p>Mark the time this button pressed on the screen with a thin white line</p> <p>Keyboard Shortcuts: INS = add rewind marker</p>
	<p>Clear data plotting since last marked point. If no marker is set, clears from the left end of the screen</p> <p>Keyboard Shortcuts: DEL = rewind to marker or start</p>
	<p>Clear all data in the plot view.</p> <p>Keyboard Shortcuts: HOME = clear all data</p>
	<p>Select which eye traces to be displayed (“VIS”) or adjusted (“ADJ”). At least one of the eye traces must be visible.</p> <p>Keyboard Shortcuts: X or Y = data trace to select or view</p>
	<p>Select zooming level (or use ALT + ↑ and ALT + ↓ keys). These buttons will only be available when the plotting data type is Gaze, Angle, or HREF.</p> <p>Keyboard Shortcuts: ALT + ↑/↓ = adjust zooming levels</p>

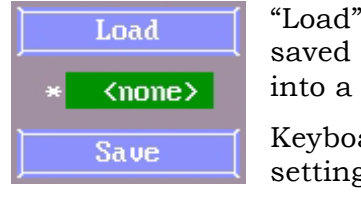
	<p>Set the gain value when used with mouse or ALT+ ↑ and ALT+ ↓ keys. These buttons will only be available when the plotting data is RAW or Analog.</p> <p>Keyboard Shortcuts: ALT + ↑/↓ = adjust gain values</p>
	<p>Scroll the eye traces up or down (or use CTRL + ↑ and CTRL + ↓ keys). These buttons will only be available when the plotting data type is Gaze, Angle, or HREF</p> <p>Keyboard Shortcuts: CTRL+ ↑/↓ = Control scrolling</p>
	<p>Select offsets when used with mouse or CTRL + ↑ and CTRL+ ↓ keys. These buttons will only be available when the plotting data is set to RAW or Analog.</p> <p>Keyboard Shortcuts: CTRL+ ↑/↓ = Adjust offset values</p>
	<p>Undo the last view or gain/offset change.</p> <p>Keyboard Shortcuts: U = undo last view or gain/offset change</p>
	<p>Change to the default view or gain/offset.</p> <p>Keyboard Shortcuts: C = revert to default view</p>
	<p>Fit all data to view, auto gain/offset adjusting.</p> <p>Keyboard Shortcuts: Tab = fit all data to view</p>
	<p>“Load” the Analog or Raw gain and offset settings from a saved .PRE file. “Save” Analog or Raw Gain and Offset settings into a .PRE file.</p> <p>Keyboard Shortcuts: L = load Analog or Raw gain/offset settings; S = Save Analog or Raw gain/offset settings;</p>

2.4.8.4 Record Screen Key Shortcuts

Key	Function
ESC	Stop the recording and exit to output screen
CTRL + ALT + A	Abort trial menu
G	Toggle between Gaze Cursor view and Plot View
Plot Mode Only (Recording Screen).	
X or Y	Data trace to select or view
< or >	Change plot speed
P	Pause or resume plotting (also marks)
INS	Add a rewinding marker
DEL	Rewind to marker or start
HOME	Clear all data
U	Undo last view or gain/offset change.

C	Change to default view or gain/offset.
TAB	Fit all data to view, auto gain/offset adjusting
CTRL ↑ or ↓	Adjust offsets (for raw and analog) or scrolling (for gaze, HREF, and angle).
ALT ↑ or ↓	Adjust gain (for raw and analog) or zooming (for gaze, HREF, and angle).
L or S	Load or Save Analog or raw Gain and Offset

2.4.8.5 Example Gain and Offset Adjustments

Imagine a simple saccade task in which a target is displayed at the left, center, or right side of the screen, and you plan to send out a -4 volt signal when the participant fixates on a target appearing on the left end of the display and a +4 volt signal when the participant fixates on the target on the right end.

- 1) Go to the Set Option screen. Set the “Record View” as “Plotting” and “Plot” data type as “Analog”. If you don’t have an analog card installed on the Host PC, set the “Plot” data type to “RAW”.
- 2) Start the eye tracker recording. Present three targets at the left-side, right-side, and center of the screen, each for 5 seconds and instruct the participant to fixate on the targets as precisely as possible. (If you do not have a display program ready, you may mark the target positions on a piece of cardboard.)
- 3) Click on the “Pause” button to pause screen updating. Make sure that only the “ADJ” button of the X trace is selected.
- 4) Please note the white bar drawn at the right end of the graph. This bar sets the upper and lower bounds for gain and offset adjustments – dragging the mouse cursor inside this region will change the offset of the adjustments; dragging the mouse cursor outside this region does the gain adjustments.
- 5) To adjust the gain of the eye traces, place the mouse cursor outside of the regions bounds by the white bar. Drag the mouse up to increase the gain or down to decrease the gain. Do the adjustment until the span of the upper and lower eye traces is about 8 volts. You will notice that both the gain and offset values are updated when you drag the mouse up or down.
- 6) Now, place the mouse cursor in the regions bounds by the white bar. Drag the mouse up or down until the top of the eye trace is aligned with 4 volts and the bottom of the eye trace is aligned with -4 volts. Repeat steps 5 and 6 for fine tuning.
- 7) Once you are happy with the adjustments, toggle off the “ADJ” button for the eye trace so you will not accidentally modify the values.

- 8) Now your “calibration” is done. Click on the “Pause” button to continue recording (see Figure 2-13 for an example of testing the “calibration” accuracy).

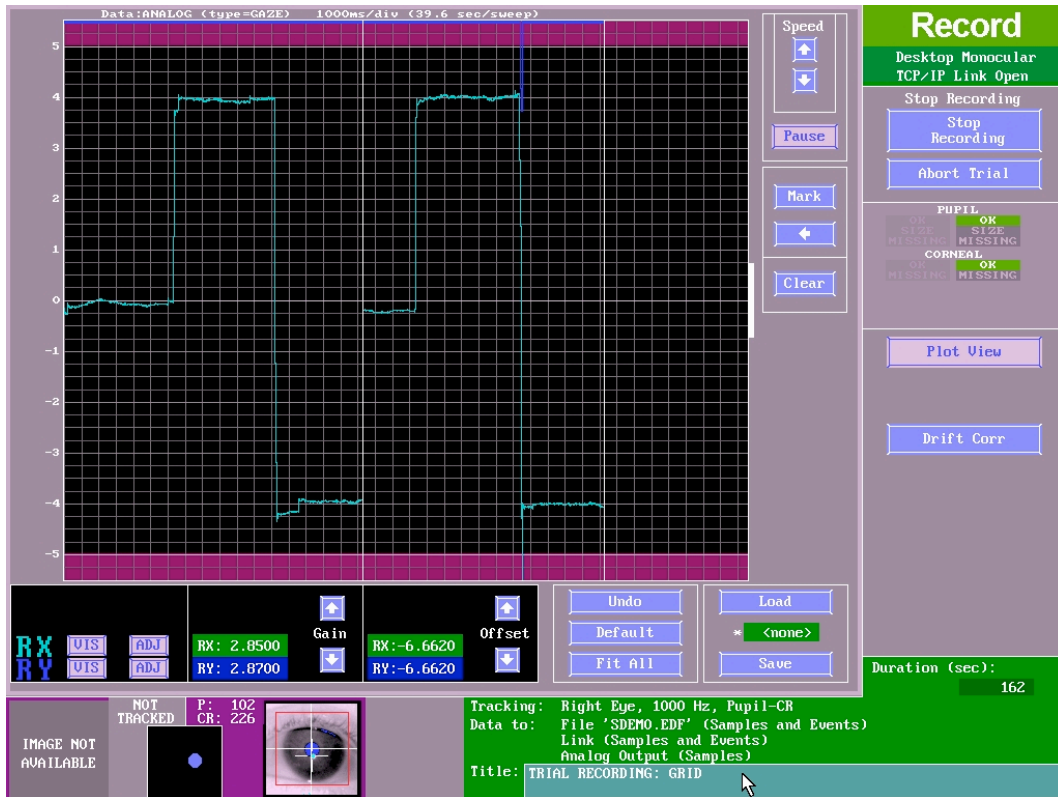

Figure 2-13: Gain/Offset Adjustments in the Plot View

2.5 Status Panel

The Status Panel allows users to monitor the status of the camera image of the tracked eyes throughout the setup, calibration, validation and recording phases of every experiment. A visual indicator, illustrated in the figure below, is present on the right hand side of the Calibrate, Validate, Drift Correct, Output and Record screens and gives the operator a complete and continuous status report of the camera image. For the Remote Mode, status of target tracking is also provided.

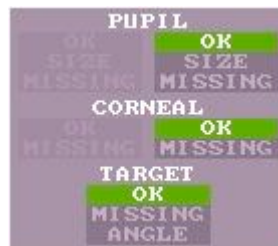

Figure 2-14: EyeLink 1000 Plus Status Panel

For both the Pupil and Corneal Reflection status reports, the left Status Panel column corresponds to the left eye and the right column corresponds to the

right eye; the status column representing the eye not being used is grayed out. The Status Panel indicators are summarized as follows:

Pupil

OK (green) Pupil present and can be tracked at selected sample rate
SIZE (yellow) Occurs when the pupil size is larger or smaller than the maximum or minimum allowed pupil size.
MISSING (red) Pupil not present;
BOUNDS (red) Pupil is missing, or the fitted gaze data doesn't appear to be valid.

Corneal (only operational in Pupil-CR mode)

OK (green) Corneal reflection is present and can be tracked
MISSING (red) Corneal reflection is not present
BOUNDS (red) CR is missing, or the fitted gaze data doesn't appear to be valid.

Target (only available in the Remote Mode)

OK (green) Target is present and can be tracked
MISSING (red) Target is not present.
ANGLE (red) Target has too large an angle to be tracked properly.

When working in the Output and Record screens, if the Pupil Size warning is on, at least one sample was interpolated by the system and is indicated by **(Int)** appearing beside the 'Pupil' label in the Status Panel. All status flags remain on for a minimum of 200 msec, even if the condition that caused the warning or error to be raised lasted for less than 200 msec.

2.6 Mouse Simulation Mode

You can use a mouse on the EyeLink 1000 Plus Host PC to simulate an eye to practice calibration and tracking alone or to test experiments during development if a test participant is not available. Select "Mouse Simulation" in the "Set Options" screen to enable mouse simulation. If the mouse does not move the eye position, you will need to perform a calibration on the mouse device (See section 3.7 "Calibration").

3. An EyeLink 1000 Plus Tutorial: Running an Experiment

The following tutorial will demonstrate and test the EyeLink 1000 Plus system, assuming that you have already arranged a proper layout of the EyeLink 1000 Plus equipment and configured PHYSICAL.INI for your setup (see Section 1.1 “Suggested Equipment Layout” and Section 8.4 “Customizing Your PHYSICAL.INI Settings” of the “EyeLink 1000 Plus Installation Guide” document). A summary of the setup procedure can be found at the end of the discussion (“3.13 EyeLink 1000 Plus Setup Summary”). This section leads you through a straightforward participant setup and pupil-corneal reflection eye-tracking demonstration. For the easiest setup, you should select a participant for the test that can sit still when required, and does not wear eyeglasses. Once comfortable on these participants, you can tackle more complex setup scenarios.

During the session description we take the opportunity to discuss many important aspects of system use. These may make the setup appear long, but a practiced experimenter can set up a participant in much less than five minutes, including calibration and validation.

If the EyeLink host software is not yet running on the Host PC, start it by clicking on the EyeLink logo at the top-left corner of the File Manager (see section 2.2 “Starting the Host Application” of this document).

IMPORTANT: Remember to exit the EyeLink software by pressing the key combination CTRL+ALT+Q and clicking on the shutdown button on the File Manager toolbar. Avoid switching off the computer while the EyeLink 1000 Plus host software is still running as data may be lost or get corrupted.

The current chapter illustrates how to run through a typical eye tracker session using the TRACK.EXE example from the Windows Display Software. If you prefer to use other examples or operating system, please see section 3.15 of the current chapter. To start the TRACK example on a Windows Display PC, click:

Start -> All Programs -> SR Research -> EyeLink -> TRACK

When TRACK starts, a copyright message will appear on the Display PC, and the status message (at the top right) should read “TCP/IP Link Open” on the Host PC.

A dialog will appear on the Display PC asking you to enter a Track EDF file name. Enter “TEST” (without the quotes “ ”).

Once TRACK is running, control is either from the Host PC or Display PC keyboard, and the application will reflect the state of the EyeLink 1000 Plus

software by drawing appropriate graphics on the Display PC. The advantage of the Display PC based control is that it allows the operator to work near the participant, or for self-setup. We will perform most of the EyeLink 1000 Plus setup by using the Host PC keyboard.

3.1 The Camera Setup Screen

The first step in an eye-tracking session is to set up the participant and eye tracker. Begin by navigating to the Camera Setup screen. You will see camera-image windows in the middle of the display, a global view of the tracked eye on the top and zoomed view(s) at the bottom. Navigation buttons to access other Tracker screens are on the right, while selection buttons for tracking mode and other functions are on the left of the screen.

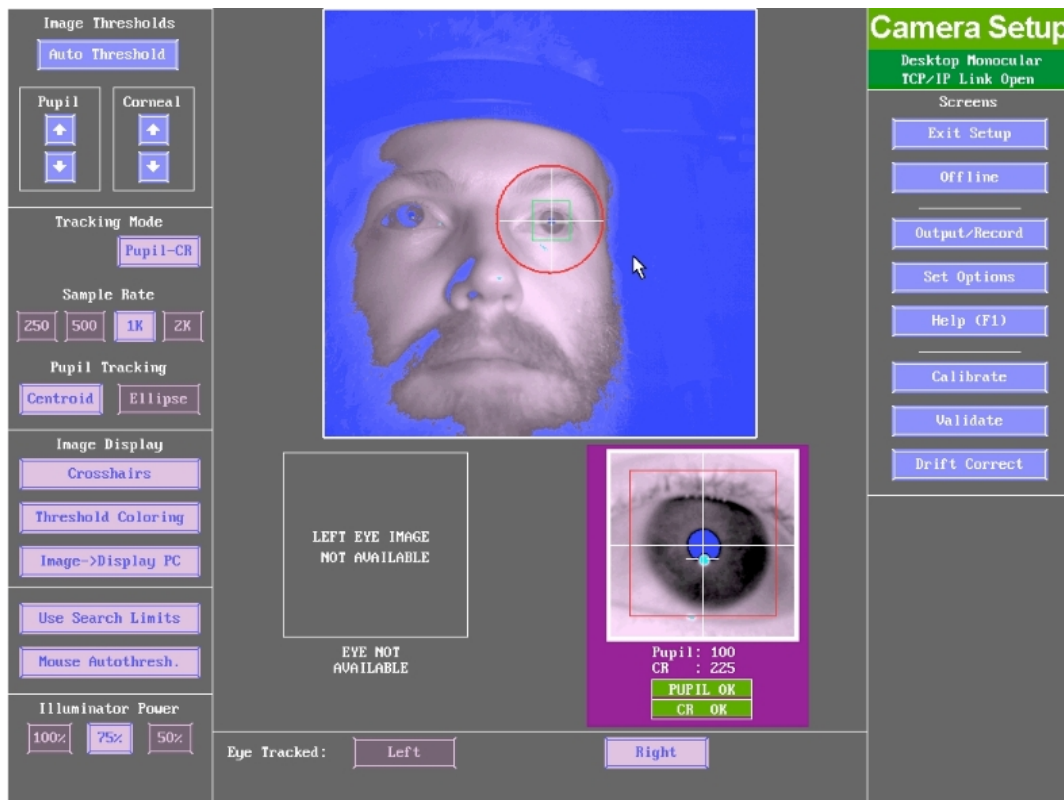

Figure 3-1: Example Camera Setup Screen (Desktop Mount).

Throughout the EyeLink 1000 Plus Host software, you can use the Host PC mouse to select options and navigate throughout the tracker screen. Almost every button has an equivalent keyboard shortcut. The key shortcut mappings available for the currently displayed screen can be accessed via the Help button, or by pressing F1.

In the Camera Setup screen, you can select one of the camera views by pressing the ← and ⇒ cursor keys. If an experiment is open on the Display PC (like TRACK.EXE) then pressing the “Image → Display PC” button from the Camera Setup screen will start displaying an image of the selected camera on the Display PC’s monitor.

3.2 Participant Setup

To practice setting up the camera, you will need a participant. If none is available, you can practice this part of the procedure on yourself. It may be easier to practice on yourself first, but be sure to repeat with several participants later. Because all keys on the display PC keyboard are sent to the EyeLink software by TRACK, you can practice calibration and observe your tracked eye-position too. Since no menus appear on the Display PC, you will have to be able to see the Host PC display as well.

NOTE: Ideally, to prevent small drifts in thresholds, EyeLink 1000 Plus electronics should be powered on for about 10-15 minutes before starting the recording.

The EyeLink 1000 Plus has several mount and camera combinations: Desktop Mount with head stabilization, Desktop Mount without head stabilization (Remote Mode), Tower Mount, Primate Mount, LCD Arm Mount, and Long Range Mount. All of the mounts supports either monocular or binocular recording. The Long Range mount requires an additional Fiber Optic Camera Head to be installed, and the Remote Mode (Desktop and LCD Arm Mounts) require a target sticker to be affixed to the participant’s forehead.

Depending on the license of your system and the requirements of your application, you will need to choose one of the above recording modes.

Please continue with one of the following participant setup tutorials.

Highly Accurate, Head Stabilized Monocular or Binocular Recording

3.2.1 “Desktop Mount Participant Setup, Monocular”

3.2.2 “Desktop Mount Participant Setup, Binocular”

Accurate Monocular or Binocular Recording Without Head Stabilization

3.2.3 “Desktop Mount Participant Setup, Monocular Remote Mode”

3.2.4 “Desktop Mount Participant Setup, Binocular Remote Mode”

Using the LCD Arm Mount- Positioning the Apparatus

3.2.5 “LCD Arm Mount Participant Setup”

Highly Accurate, Wide Field-of-View Recording

<p>3.2.6 “Tower Mount Participant Setup, Monocular or Binocular” Highly Accurate, Wide Field-of-View Recording with Primates</p> <p>3.2.7 “Primate Mount Participant Setup, Monocular or Binocular” Highly Accurate, Head Stabilized Recording in the MRI/MEG Environment</p> <p>3.2.8 “Long Range Mount Participant Setup, Monocular or Binocular”</p>

3.2.1 Desktop Mount Participant Setup, Monocular

The EyeLink Desktop Mount can be configured to track monocular or binocular eye movements up to 2000 Hz depending on the system model and licensing. Take the following steps if you plan to set up the EyeLink 1000 Plus Desktop Mount for monocular tracking.

- 1) If you are using the head support supplied by SR Research Ltd., please install the forehead rest part.
- 2) The Display PC monitor should be set such that when the participants are seated and looking straight ahead, their eyes are level with the top 25% of the monitor.
- 3) Position the monitor so that it subtends no more than 32 degrees of visual angle horizontally and 25 degrees of visual angle vertically for the participant. The eye-to-monitor distance should be at least 1.75 times the display width to ensure that it falls within the trackable range. If you are using a large/wide-screen monitor, this means that there will be a gap between the camera and monitor. Please measure the screen dimension and viewing distance and update screen settings for the tracker (see section 8.4 of the EyeLink 1000 Plus Installation Guide).
- 4) The desktop mount should be placed at a distance of 40 to 70 cm from the observer (measured from the top knob on the front of the Desktop Mount to the front of the chinrest). The ideal distance is about 50 to 55 cm.
- 5) Position the eye tracker so that its top knob is centered horizontally on the front of the monitor. The Desktop Mount should also be raised so that the top of the illuminator is as close as possible to the lower edge of the visible part of the monitor without blocking the participant’s view. The redesigned desktop mount (see Figure 3-2) comes with a height adjustment post at the base to make this adjustment easier.
- 6) Check whether the 35 mm lens (without a focusing arm) has been installed. Please remove the lens cap if it is still on.

- 7) Start the EyeLink Host PC application and go to the “Set Options” Screen. Click “Configuration” and make sure the option “Desktop ~ Stabilized Head ~ Monocular ~ 35mm lens | MTABLER” is selected.
- 8) Now go to the camera setup screen. Set the “Illuminator Power” level in the lower-left corner of the screen to 75%.



Figure 3-2: Parts of the EyeLink 1000 Plus Desktop Mount

Ask the participant to be seated. Adjust the height of the chair so that the participant is comfortable and their eyes are aligned to the upper quarter of the monitor. Ask the participant to lean her/his forehead against the forehead rest and adjust the height of the chinrest so that the participant’s chin rests comfortably on the chin rest pad while maintaining the eye alignment to the top 25% of the screen. If necessary, loosen the big knob on the Desktop Mount to adjust the angle of the camera so that the eye to be tracked appears in the center of the global view of the camera image. Now tighten the knobs.

In the global view window, the eye to be tracked should appear in the center of the camera image whereas the untracked eye should appear near the edge or outside of the camera view. To avoid accidental tracking of the unintended eye, enable the search limits. Move the Host PC mouse cursor on top of the tracked eye and click on the left mouse button. The camera image for the eye should now be displayed in the zoomed view. If the pupil is detected, a red box and the crosshair will now be drawn on the eye image.

Please note that for most participants, you will just need to adjust the height of the chinrest and chair to get the intended camera image without changing the Desktop Mount settings. However, for participants wearing glasses, depending on the shape and reflection of the glasses, you may need to make slight adjustments to the Desktop Mount (e.g., moving the camera closer to the participant, lowering the position of the camera, and/or adjusting the angle of

the illuminator and camera) so that reflections from the glass will not interfere with pupil acquisition. The left panel of the following figure illustrates a good camera setup whereas the reflections in the right panel block the pupil image.

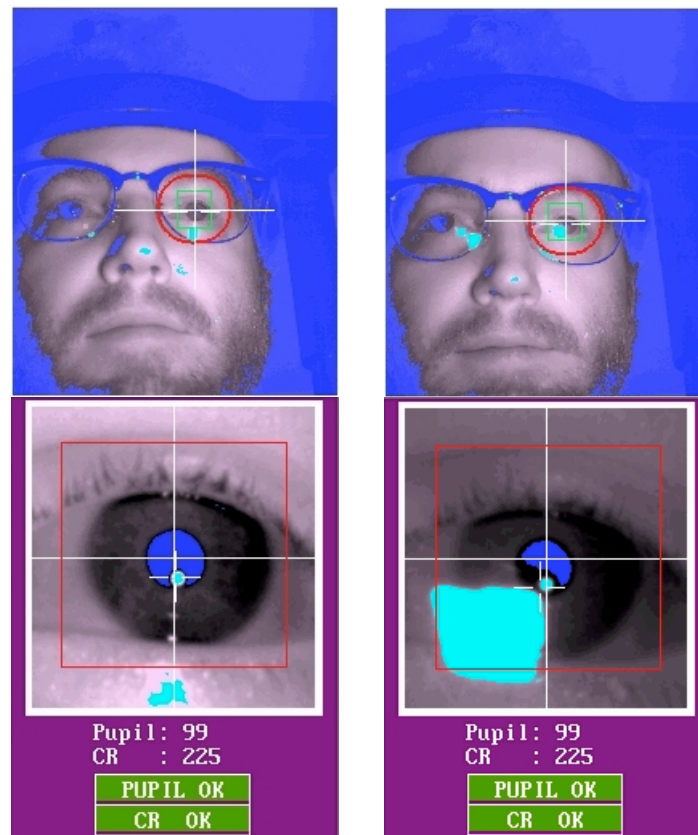

Figure 3-3: Camera Setup with Participants Wearing Glasses

If the image becomes too dark or too light, wait one second while the auto-contrast adjusts itself. If the blue thresholded area in the display is interfering with setup, press the “Threshold Coloring” button (or ‘T’ on the keyboard) to remove the threshold color overlay. In TRACK.EXE, you can use keys on either the Display or Host PC to perform all keyboard shortcut operations while the eye image is displayed.

The camera should be focused by rotating the lens focusing ring. Turn the lens by placing your thumb on the bottom of the lens and turning the focusing ring by sliding your index finger along the top of the focusing ring. This will prevent the camera image or the illumination to the eye from being blocked (see Figure 3-4). Look closely at the eye image on the zoomed view while adjusting the focusing ring until the eye image is clear. If a turquoise (CR signal) appears near the pupil, the best focus will minimize the size of this colored circle.

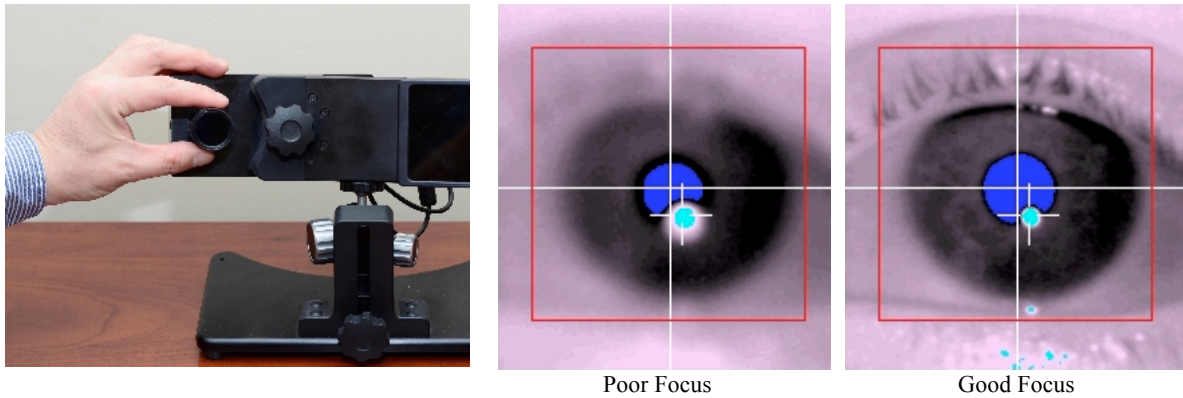

Figure 3-4: Focusing the Desktop Mount Camera

By default, the “Illuminator Power” level in the Camera Setup screen is set to 75% which is optimal when the camera is placed at the recommended distance. If the Desktop Mount is placed far away from the participant or if the pupil is not reliably acquired, you may consider increasing the illumination level to 100%.

Now proceed to section 3.3 “Setting Pupil Threshold”.

3.2.2 Desktop Mount Participant Setup, Binocular

Binocular recording using the Desktop Mount is essentially the same as the monocular recording described in the previous section. Therefore, the current section just highlights the steps that are unique to the binocular tracking.

- 1) Start the EyeLink host application and click “Set Options” button. Check the “Configuration” is set to “Desktop ~ Stabilized Head ~ Binoc/Monoc ~ 35 mm lens | BTABLER”. Press the Enter key to go back to the camera setup screen.
- 2) Adjust the position/angle of the desktop mount so that eyes appear in the center of the global view of the camera image. A dotted vertical line is drawn in the camera image to represent the hemifields in which the left and right eyes will appear (see Figure 3-5). Make sure the dotted line is between the two eyes (**even if the binocular mode is used for monocular eye tracking**). Move the Desktop Mount to the left or right or loosen the knobs and adjust the camera angle slightly so that the illumination level and pupil/CR threshold values are similar between the two eyes. For the redesigned desktop mount, the dotted line may not align with the center of the face precisely.

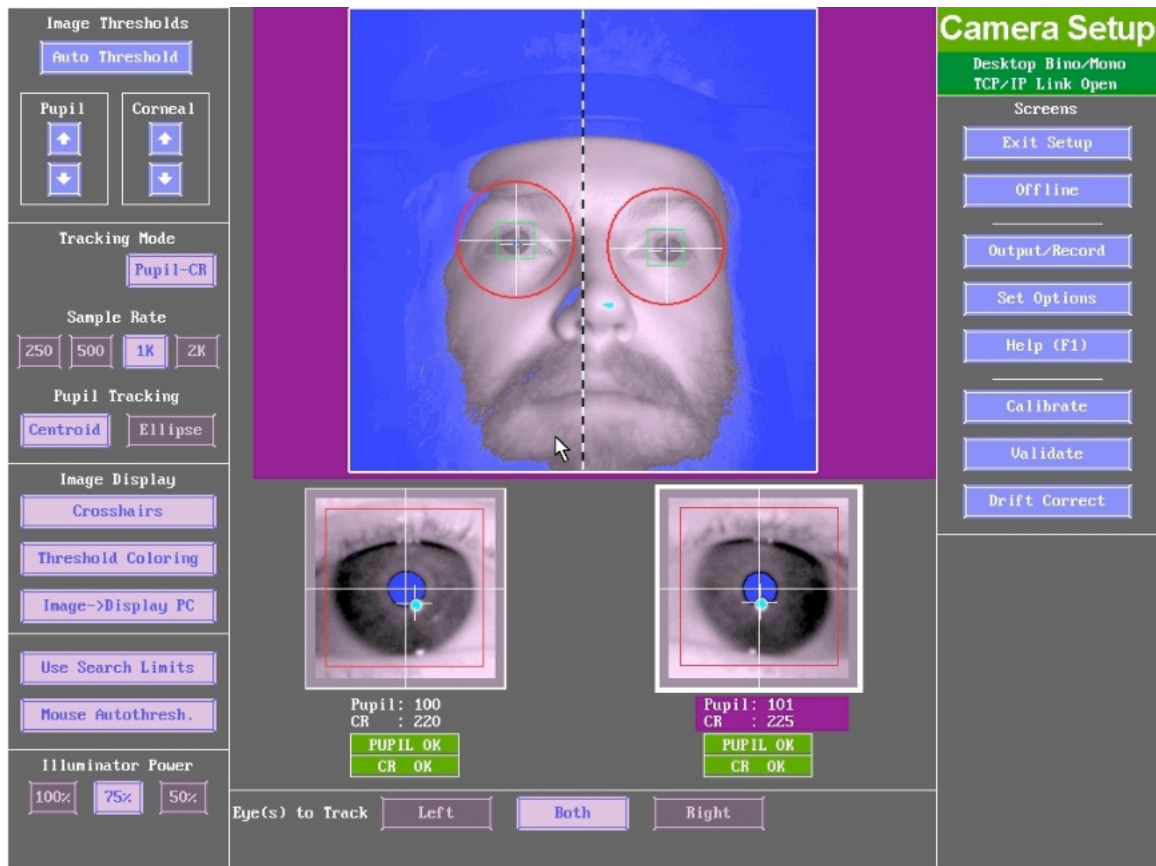

Figure 3-5: Camera Setup Screen Desktop Mount, Binocular Recording

- 3) Enable the “Use Search Limits” button. In the global camera view, click on top of the left pupil so that the search limit box is centered on it. The camera image for the left eye should be displayed in the zoomed view, with a red box and the crosshair drawn on top of the pupil image. Now click on the right pupil to center the search limit box.

Now focus the camera and continue with section 3.3 “Setting Pupil Threshold”.

3.2.3 Desktop Mount Participant Setup, Monocular Remote Mode

The Remote Mode of the EyeLink 1000 Plus eye tracker is designed for applications where a chin rest or head mount is not desirable or perhaps even possible (e.g., patient work, gerontology, infants/young children, etc.). The Remote Mode provides up to 1000 Hz eye position tracking as well as up to 1000 Hz head distance estimation via the use of a small target sticker placed on the participant’s forehead.

If your system is licensed to use the EyeLink Remote Mode, take the following steps to set up the camera and perform image adjustments.

- 1) For the Remote Mode, attach the 16 mm lens (shipped standard with a short adjustable focus arm or small wheel) to the camera. The system by default is configured to use 16 mm remote lens. Some systems may also be supplied with a 25 mm remote lens (with a special marking on the focusing wheel). The 25 mm lens provides better recording data quality than the 16 mm lens at the expense of a smaller head box; the 25 mm lens is recommended when recording at 1000 Hz. **It is important to make sure the lens settings on the host software matches the physical lens installed on the camera.**
- 2) The Display PC monitor should be set such that when the participants are seated and looking straight ahead, their eyes are level with the top quarter of the monitor.
- 3) Ideally the Desktop Mount should be placed at a distance of about 55-60 cm from the participant's eyes. This means that if you are using a monitor smaller than 20", the Desktop Mount can be placed right in front of the monitor with no extra space between them. If you are using a larger monitor, it will be necessary to move the monitor back while keeping the Desktop Mount at its optimal distance from the participant, so as to increase the distance between the participant and the screen while still ensuring that the eye tracker can track the participants properly (the maximum viewing angle of the display should be within 32° horizontally and 25° vertically). In such cases, measure the distance (in millimeters) between the lens (at the point where the lens connects to the camera) to the display monitor and update the last screen of the "Screen Settings" configuration tool (see section 8.4 of the EyeLink 1000 Plus Installation Guide). This step is very important for the head movement compensation when recording the eye position data in the Remote Mode.
- 4) The Camera Screw of the Desktop Mount should be aligned with the horizontal center of the monitor. For maximum eye tracking range, the Mount should be raised so that the top of the illuminator is parallel with, and as close as possible to, the lower edge of the visible part of the monitor without blocking the participant's view of the screen. To keep the viewing distance relatively constant throughout a recording session, a comfortable, high-backed, stable chair for the participant is recommended.
- 5) Start the Host PC application and go to the "Set Options" screen. If your system is licensed for remote eye tracking, you should now see to "Desktop (Remote Mode) ~ Target Sticker ~ Monocular ~ 16/25 mm lens | RTABLER" as one of the "Configuration" options. Select your mount type. Version 5.08

or later of the host software displays an additional Lens configuration selecting the Remote mode. Please make sure the lens selected in the Set Options screen matches the actual lens installed on the camera so that a proper target-to-camera distance can be reported.

- 6) Go to the Camera Setup screen. Make sure the lens cap has been removed. A camera image should now be displayed in the global view of Camera Setup screen. Ask the participant to be seated. Adjust the height of the chair so that the participant is comfortable and his/her line of sight is to the top 25% of the screen. Adjust your mount position so that the eye to be tracked appears in the center of the global camera view (see Figure 3-6).

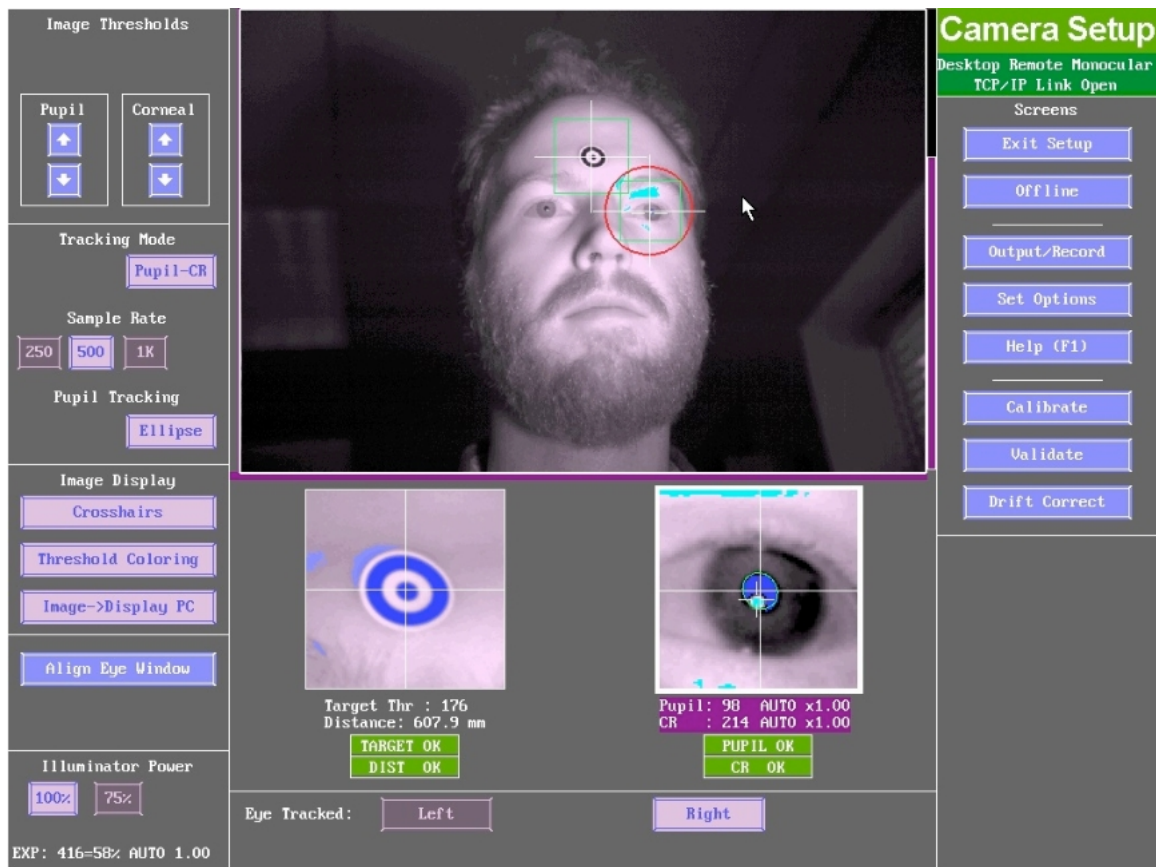

Figure 3-6: Camera Setup Screen with the Monocular Remote Mode

- 7) Place a target sticker on the participant's forehead (see Figure 3-7). This small target sticker allows tracking of head position even when the pupil image is lost (i.e., during blinks or sudden movements). Ideally, it should be just above the eyebrow of the tracked eye or on the forehead between the two eyes. If the target sticker is placed too much towards the temporal side

of the forehead (see bottom panel of Figure 3-7), the tracker may report an ANGLE error in the status panel when the participant rotates the head in the direction of the sticker.

One other potential problem concerns occlusion of the pupil image by the nose when the participant's head is rotated. If this presents a problem because the majority of a stimulus involves the participant looking to the side of space where the illuminator resides (opposite the camera), consider tracking the eye on the same side of space as the camera. One side of space will still afford a relatively more restricted view due to occlusion of the eye by the nose, but now the restricted range of looking will be on the same side of space as the camera. For example, when tracking the left eye, a greater range is available when the participant is looking to the right, because when the participant looks far to the left, the nose will occlude the camera's view of the left eye.

- 8) For optimal performance, adjust the participant's seating distance so that the tracker reports a target-camera distance of about 600 mm in the zoomed target view. If you use a 940 nm illuminator, consider moving the participant closer to a target-camera distance of about 550 mm. If participant is seated too close to the camera, the Host PC will display a "DIST CLOSE" error. If the participant is seated too far from the camera, the tracker will report a "DIST FAR" error. If the tracked eye does not appear centered in the global camera view, the angle of the Desktop Mount may be adjusted slightly.

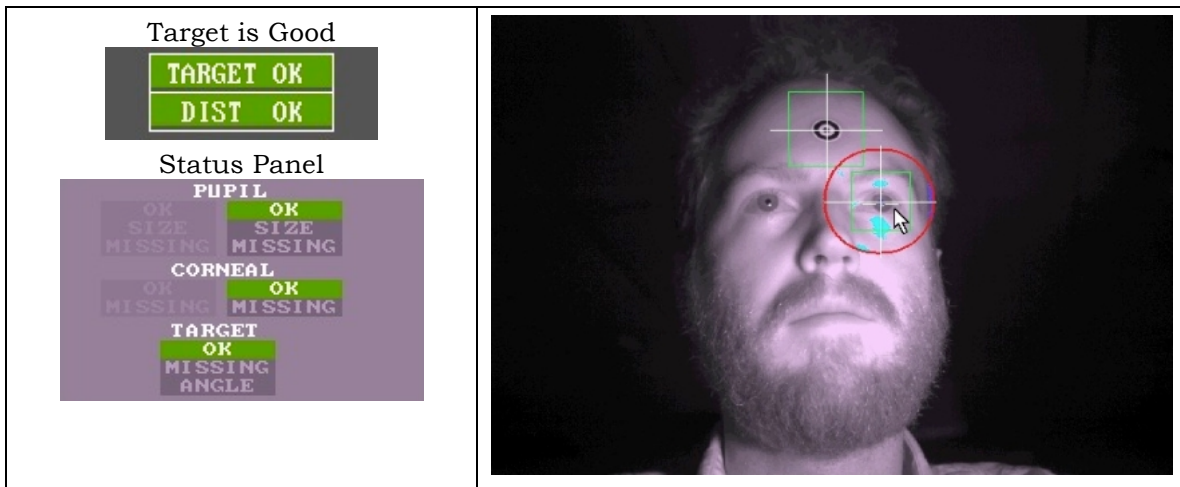



Figure 3-7: EyeLink Remote Target Placement

- 9) In the global view window of the camera image (Host or Display PC), now select the tracked pupil using the mouse cursor. If the camera image is not focused, rotate the focusing arm and look closely at the eye image on the zoomed view. The best focus will minimize the size of the corneal reflection circle (usually colored turquoise).
- 10) If the pupil is detected, crosshairs will now be drawn on the eye image in the global view. In the zoomed view, the pupil area is thresholded in blue. If the blue area in the display is interfering with setup, press the “Threshold Coloring” button (or ‘T’ on the keyboard) to remove the threshold overlay. In TRACK.EXE, you can use keys on either the Display or Host PC to perform all keyboard shortcut operations while the eye image is displayed.
- 11) A properly thresholded pupil should be solidly blue, with minimal blue elsewhere in the image. If the threshold is too low, the blue area will be smaller than the pupil, and the eye image will show excessive movement. If the threshold is too high, there will be shadows at the edges and corners of the eye, especially when the eye is rotated. Therefore, it is important that the experimenter have the participant look at the four corners of the monitor, and watch for potential pupil image problems. One common problem is for shadows at the corners of the eye, which can disrupt tracking of the pupil. Another common issue is that the corneal reflection becomes distorted or even disappears. This typically occurs when participants look to the top-left or top-right corner. This is generally an indication that the monitor is placed too close to the participant (i.e., a large viewing angle), forcing them to rotate their eye beyond the trackable range of the system.

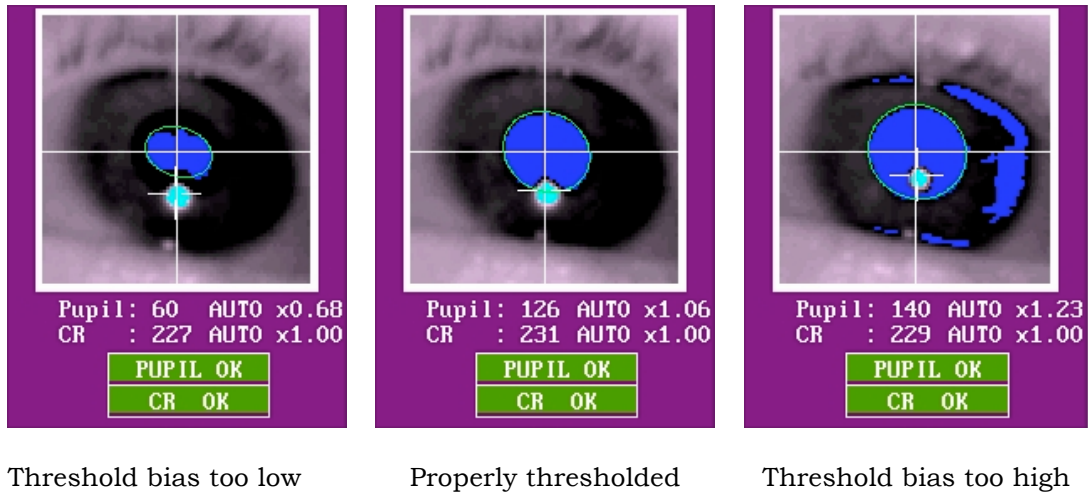

Figure 3-8: Pupil and CR Thresholds and Bias Values

- 12) In the zoomed camera image, the threshold values for pupil and corneal reflection are displayed under the camera image. Unlike other tracking modes of the EyeLink 1000 Plus eye tracker, these threshold values are automatically updated in the Remote Mode. The number beside the pupil threshold value is pupil bias – the extent to which the pupil threshold is modulated (see Figure 3-8). The user may adjust the bias using the pupil threshold adjustment buttons or with the UP and DOWN keys. Raising the bias increases pupil coverage (i.e., increasing the blue area) while lowering the bias decreases the pupil coverage (i.e., decreasing the blue area). Generally speaking, pupil biases should be in the range of 0.90 to 1.10. A value around 1.05 is recommended, though this will vary depending on the participant.
- 13) The operator can easily tell if the pupil has been detected because the image on the Host PC will have a crosshairs indicating its center. A green ellipse, updated each refresh, is drawn based on the elliptical pupil fitting algorithms (see section 3.6 “Pupil Tracking Algorithm”). If a shadow interferes with pupil detection, or if the eye image is severely under thresholded, the crosshair and ellipse fitting will disappear and the pupil will be lost. On the Host PC, an error message “No Pupil” will appear below the zoomed eye image.
- 14) The Remote Mode exclusively uses Pupil-CR mode. The CR is identified by a filled (turquoise or yellow), white circle marked by a crosshair. The CR threshold value and bias are displayed under the zoomed camera view. The CR threshold is updated automatically and CR bias can be manually adjusted using buttons, or the + and – keys. In general, the CR bias values should range from 0.9 to 1.1 (a value around 1.0 is recommended). Once the

threshold bias is adjusted, have the participant slowly look along the edges of the display surface and ensure that the CR is consistently detected and tracked. If the CR is inconsistently detected or lost entirely, a red warning message will appear below the small camera image for the eye indicating “No CR” on the Host PC.

- 15) By default, the “Illuminator Power” level of the Remote Mode is set to 100%. If the Desktop Mount is placed too close to the participant or if the CR signal is not reliably acquired, you may consider lowering the illumination level to 75%. An unusually high pupil threshold value (well above 120) is an indication that the illumination level might be too high.
- 16) Version 5.03 of the EyeLink host software implements exposure control, which is used to adjust the brightness of the camera image when the eye-to-camera distance changes and to improve the dynamic range of the EyeLink 1000 Plus camera. Unlike other head-supported tracking modes, the distance between the participant and the eye tracker and the position of the tracked eyes in the camera image can vary quite a bit during recording in the Remote Mode. Since the effective brightness of the illuminator output changes as a function of distance squared, this means that the brightness of the camera image and thus the pupil and target thresholds can vary a lot if the viewing distance and image position changes. Exposure control in the EyeLink host software is used to adjust the exposure duration of each camera frame to avoid getting overexposed or underexposed camera images. In the Remote Mode, an automatic exposure control is implemented using the brightness of the target sticker as a reference. This adjustment in the exposure duration is primarily based on the target-camera distance but can also be influenced by other factors (e.g., position in the camera sensor, eye rotation angle, etc).

The auto exposure control can be enabled or disabled by pressing CTRL + E (auto exposure is turned off if "AUTO" is missing from the exposure control text). When operating in the Remote Mode, it is recommended that the default settings is used (i.e., Auto Exposure enabled) so that the eye tracker automatically adjusts the exposure duration of the camera image frames to keep the threshold of the target and pupil relatively constant. CTRL and UP/DOWN arrow keys adjust the bias value (multiplier) of the auto exposure control. Pressing the CTRL and UP arrow keys may help if the pupil threshold is too low because of a dark camera image; pressing the CTRL and DOWN keys will help if you are getting an overexposed camera image. It is recommended that the default bias value of 1.0 be kept.

- 17) The Remote Mode draws a red search limit box that is automatically updated and moves along with the pupil. This search limit area is used to

exclude regions of the camera image (e.g., frame of the glasses, eye brow) that may otherwise be detected as a pupil/CR reflection pattern. If the search limit box isn't placed on the center of the pupil, press "A" or the "Align Eye Window" button to center it. The size and shape of the search limit area can be adjusted by first having the zoomed eye image selected and then pressing ALT and cursor keys on the host keyboard together (ALT + ↑ or ↓ to adjust the height; ALT + ← and → to adjust the width). The position of the search limits can be adjusted with SHIFT and cursor keys.

- 18) The operation of the Remote Mode is influenced by ambient lighting. In general, the pupil shrinks under bright light and dilates in a dark environment. It's important that the user check the pupil size reported in the status panel (in the Offline, Calibrate, Validate, Drift Correct, Output and Record screens; see Figure 3-9) periodically throughout recording. If a yellow size warning is constantly observed, it is likely that the pupil size is too small and as a result, the recorded data may be noisy. If this happens, first check whether the participant is seated at the recommended eye-target distance of 550-600 mm. Dimmer room lighting will also help alleviate this issue.



Pupil size looks OK

Pupil size warning (size too small)

Figure 3-9: Status Panel Pupil Size Information

- 19) Following the initial adjustments in the Camera Setup Screen, the experimenter should continuously monitor the thumbnail camera images at the lower left corner of the tracker screen when in the Offline, Calibrate, Validate, Drift Correct, Output and Record screens (see Figure 3-10). The two dots in the middle panel reflect the ever-changing target and eye positions in the global camera image. For reliable tracking, both dots should stay within the red box. Adjustment of the camera's view of the participant is advised if you experience difficulties in tracking them.

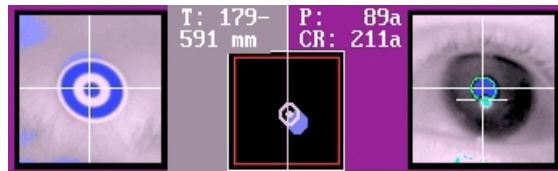

Figure 3-10: Target and Eye Positions in the Thumbnail Camera Images

Now proceed to section 3.7 “Calibration”. For the best recording accuracy in the Remote Mode, please use a 13-point calibration type.

Don’t forget to remove the target from the participant’s forehead at the end of the recording session.

3.2.4 Desktop Mount Participant Setup, Binocular Remote Mode

Version 5.03 or later of the EyeLink 1000 Plus host software supports binocular tracking in the Remote Mode up to 1000 Hz. Binocular recording in the Remote Mode is essentially the same as the monocular recording described in the previous section. Therefore, the current section just highlights the steps that are unique to the binocular tracking.

- 1) Start the EyeLink host application and click “Set Options” button. Check the “Configuration” is set to “Desktop (Remote Mode) ~ Target Sticker ~ Binoc/Monoc ~ 16/25 mm lens”. Press the Enter key to go back to the camera setup screen. Please make sure the lens reported in the upper right corner of the screen matches the actual lens installed on the camera. While the system by default is configured to use 16 mm remote lens, the 25 mm lens is recommended when high recording data quality or 1000 Hz data recording is needed.
- 2) Adjust the position/angle of the desktop mount so that eyes appear in the center of the global view of the camera image. A dotted vertical line is drawn centering on the target sticker. Make sure the target sticker is placed on the forehead between the two eyes. **Important, the dotted line should be approximately aligned with the center of the face even if the binocular mode is used for monocular eye tracking.**

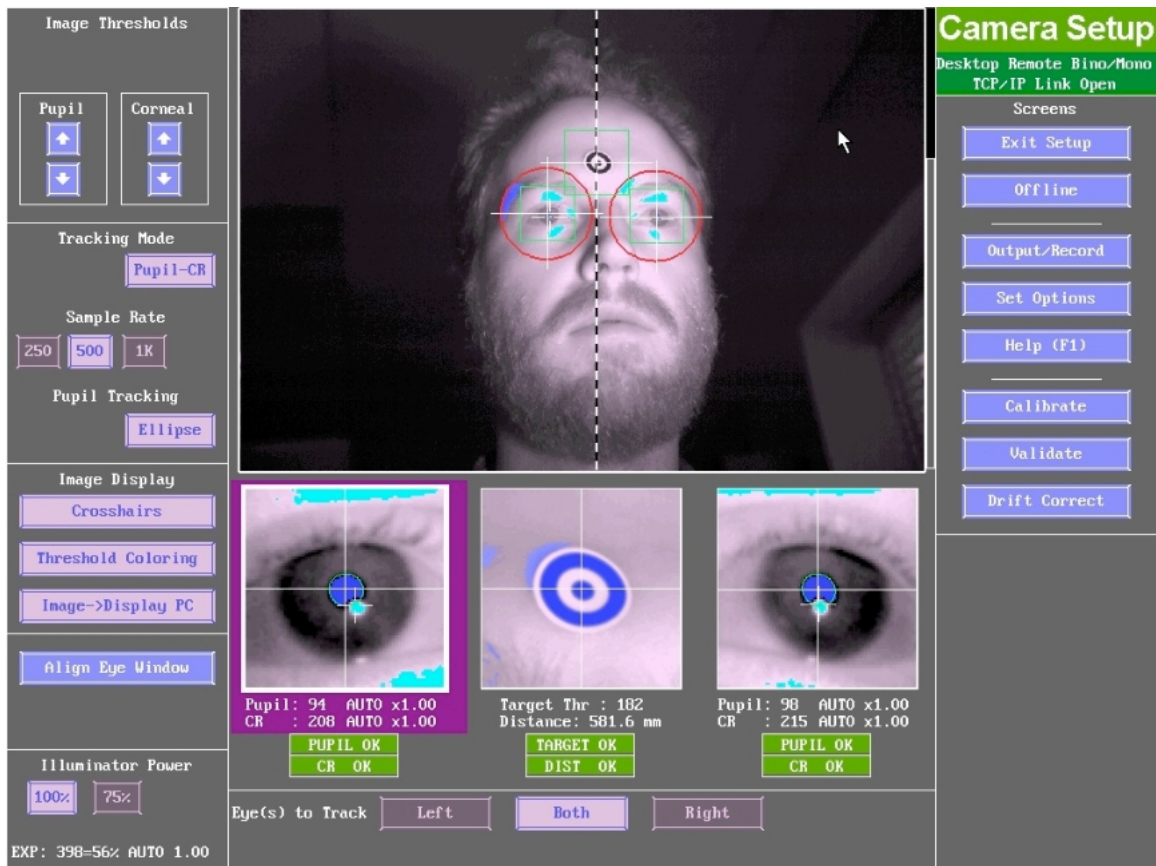

Figure 3-11 Camera Setup Screen with the Binocular Remote Mode

3.2.5 LCD Arm Mount Participant Setup

The EyeLink 1000 Plus LCD Arm Mount works in conjunction with highly accurate recording with the head stabilized or with head free recording in the Remote Mode (licensing required). Regardless of the recording mode, positioning the Arm Mount requires similar considerations. Once the Arm is in position, steps to take to collect good data are identical to those of the other mounts.

To position the Arm simply grab the entire apparatus by one or both of the handles located on either side of the LCD display and pull it into position. Note that the Arm can swing completely around, move up and down, and bend at every joint. Furthermore, the LCD display can be tilted forward or backward and rotates around the swivel joint that attaches it to the Arm.

Ideal positioning of the LCD Arm Mount places the LCD display:

- perpendicular to the viewer's line of sight,

- with their gaze horizontally centered, and
- aligned with the top quarter of the display.

If the viewer is sitting upright in a chair, this means that the monitor should form a right angle to the floor, and that their gaze should strike the monitor in the middle and in the top 25% of the display area. If the observer is reclining, then place the monitor surface so that it is parallel to, and in front of their face rather than perpendicular to the floor.

To run the tracker in the Arm Mount configuration, start the EyeLink host application and go to the Set Options screen. Check the “Configuration” is set to “Arm Mount ~ Stabilized Head ~ Monocular ~ 35 mm lens” or “Arm Mount (Remote Mode) ~ Target Sticker ~ Monocular ~ 16/25 mm lens”. Press the Enter key to go back to the camera setup screen.

A final important consideration, particularly for viewing with head stabilization is the distance between the LCD display and the observer. Having a tape measure handy to check that Arm positioning is at the viewing distance specified in the Screen Settings configuration (See Section 8.4 “Customizing Screen Settings” of the EyeLink 1000 Plus Installation Guide) is a good idea. For the EyeLink Remote, viewing distance is computed dynamically, so setting the viewing distance in the screen settings configuration is not necessary.

For instructions pertaining to the assembly, disassembly and transport of the LCD Arm Mount, see the EyeLink 1000 Plus Installation Guide.

Now that the LCD Arm Mount is in place, to continue the setup tutorial, go to either “Section 3.2.1 Desktop Mount Participant Setup, Monocular” or “Section 3.2.3 EyeLink Remote Participant Setup” if using the system without head stabilization (Remote licensing required). Keep in mind that most references to the Desktop Mount in these sections will not apply.

3.2.6 Tower Mount Participant Setup, Monocular or Binocular

NOTE: The EyeLink 1000 Plus Tower mount has been redesigned to support binocular tracking. Contact support@sr-research.com for instructions on how to use the monocular-only Tower Mount.

NOTE: Please check the height of the EyeLink 1000 Plus Tower before having a participant seated - ideally this should have the top of the display at about the same height as the forehead rest. The Tower height adjustment should only

need to be done during initial system setup and not on a participant-to-participant basis.

To run the tracker in the binocular Tower mount configuration, start the EyeLink host application and go to the Set Options screen. Make sure the “Configuration” is set to “Tower Mount (Binocular) ~ Stabilized Head ~ Binoc/Monoc ~ 25 mm | BTOWER”. Press the Enter key to go back to the camera setup screen. The host software should report the mount type as “Tower Bino/Monoc” in the upper right corner of the Camera Setup screen.

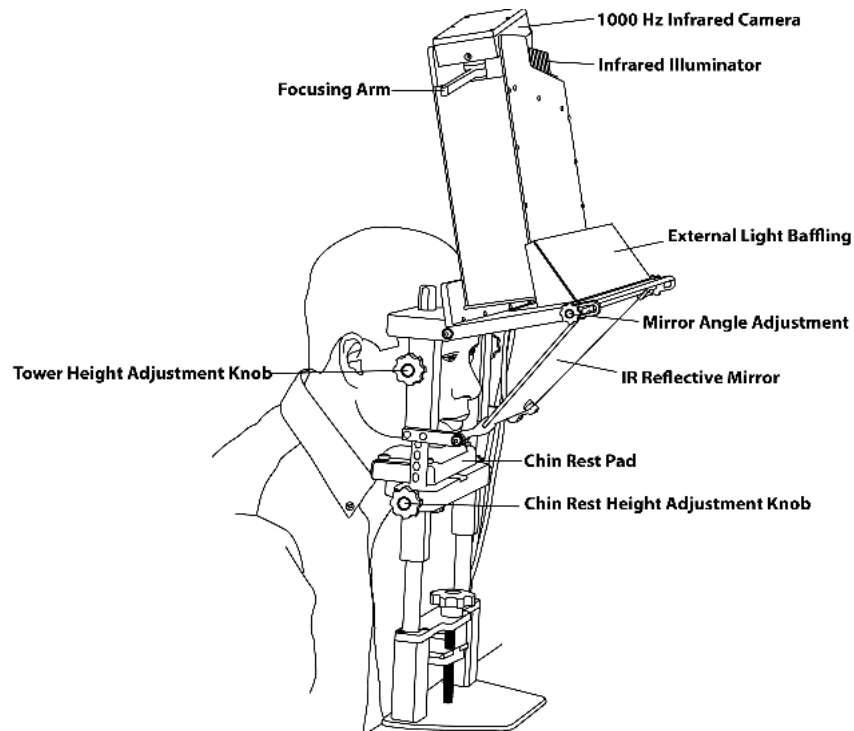

Figure 3-12: Parts of the EyeLink 1000 Plus Tower Mount

IMPORTANT: The height of the EyeLink 1000 Plus Tower should not be adjusted when a participant is using the head support device!

Before adjusting the camera image, check the mirror angle of the system. If the participant does not wear glasses, set the mirror angle to the lowest position (i.e., loosen and move the mirror-angle adjustment knobs to a position away from the participant and then tighten the knobs). This mirror angle will be compatible with most participants.

If the participant wears glasses, start with the mirror angle to middle- or high-position and then gradually adjust it during the camera setup process if necessary. Please note that the EyeLink 1000 Plus Tower mount is not

compatible with some glasses (depending on the shape of the glasses and reflectiveness of the glasses) and therefore you may not be able to track the participant even after adjusting the mirror angle; the EyeLink 1000 Plus Desktop Mount has better compatibility with glasses.

Ask the participant to lean against the forehead rest on the Tower Mount. Adjust the height of the chair so that the participant is comfortable and his/her eye line of sight intersects with the upper part of the display. The position of the forehead rest should be just above the eyebrow. The leftmost panel of Figure 3-13 shows a good chair height. The middle and right panels show the participant seated either too high or too low.

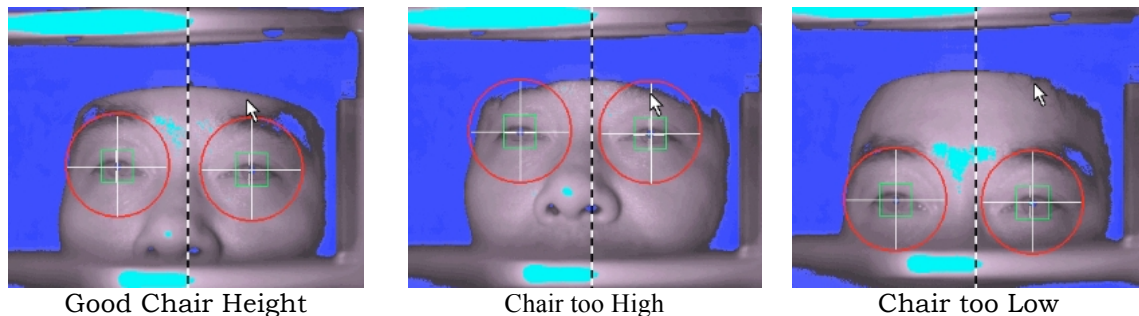

Figure 3-13: Adjust the Chair Height for EyeLink 1000 Plus Tower Mount

The experimenter should also ensure the participant's head position is vertical by adjusting the position of the chair. If the chinrest is used for the experiment, adjust the height of the chinrest pad so that the participant's head is comfortably supported. The experimenter may also slide the chinrest pad further away or closer to the participant by first loosening the knob underneath the chinrest and then tightening it.

In the global view window of the camera image, now place the Host PC mouse cursor on top of the pupil and click on the left mouse button. The camera image for the eye clicked should now be displayed in the zoomed view. If the pupil is detected, a red box and the cross will now be drawn on the eye image. The "Use Search Limits" button should be enabled so that the tracker will try to re-acquire the pupil position within the red oval in the global view of the camera image.

If the camera image becomes too dark or too light, wait one second while the auto-contrast adjusts itself. If the blue thresholded area in the display is interfering with setup, press the "Threshold Coloring" button (or 'T' on the keyboard) to remove the threshold color overlay. In TRACK.EXE, you can use keys on either the Display or Host PC to perform all keyboard shortcut operations while the eye image is displayed.

The camera should be focused by rotating the focusing arm slowly (see the left panel of Figure 3-14). Look closely at the eye image on the zoomed view while adjusting the position of the focusing arm until the eye image is clear. If a turquoise (CR signal) appears near the pupil, the best focus will minimize the size the CR dot. Now proceed to section 3.3 “Setting Pupil Threshold”.

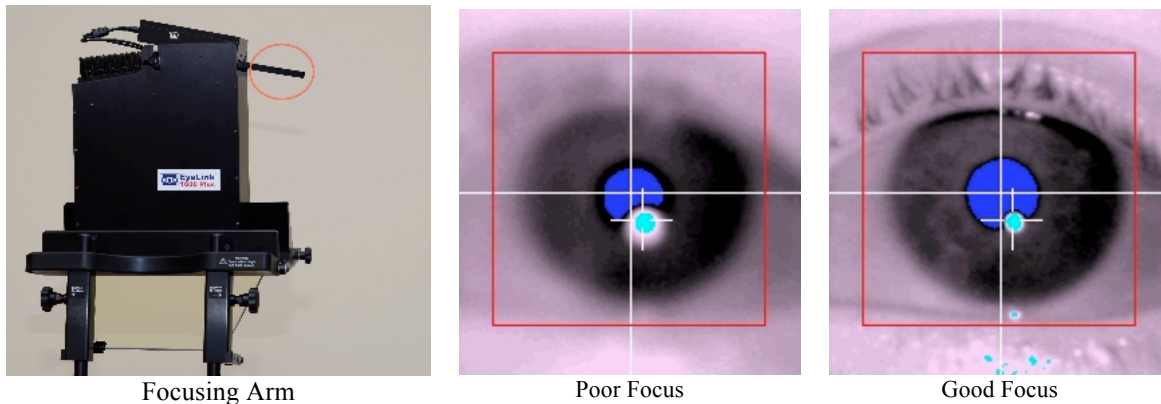

Figure 3-14: Focusing the Eye Camera for EyeLink 1000 Plus Binocular Tower Mount

3.2.7 Primate Mount Participant Setup, Monocular or Binocular

Most of the details for Primate Mount setups are documented in the Installation Guide. Once a physical setup is established, there is unlikely to be much variation in the steps taken to track eye movements as there is generally little variability in the view of the eye or the participants.

The software configuration steps for use of the Primate Mount are similar to the Tower Mount. However, while the Tower Mount is limited in its use of a single 25 mm lens, users of the Primate Mount may wish to use the 16 or 25 mm lens according to the table below.

Lens (focal length)	Distance (Camera Front to Eye)	Field of View
16 mm	240-280 mm	85 x 65 mm
25 mm	350-400 mm	85 x 65 mm

3.2.8 Long Range Mount Participant Setup, Monocular or Binocular



The EyeLink 1000 Plus Long Range Mount can be configured to track monocular eye movements at up to 2000 Hz, or binocular movements up to 1000 Hz per eye depending on camera licensing.

The EyeLink 1000 Plus Installation Guide provides information for setting up the Long Range Mount generally as well as specifically with particular types of MEG scenarios, and MRI scanner and head coil combinations. The Long Range Mount should only need to be set up once for a given eye tracking setting. Thereafter, each participant should only require a quick focus and calibration.

The following are generic instructions for setting up a particular participant. For specialized environments please consult the Installation Guide.

3.2.8.1 Monocular Long Range Participant Setup

After setting up the Long Range Mount's position, including pointing the camera and aligning the camera and illuminator, find a participant to track. This section will cover fine tuning the camera setup and calibrating your participant. MEG/MRI users should consult the Installation Guide for detailed coverage of installation in those environments. Please also read Section 3.13 of this manual on online drift correction.

- 1) Check the camera image in the global view. If the camera image is vertically flipped, this can be corrected by pressing the  button to the right of the global camera view. If the camera image is horizontally flipped, this can be corrected by pressing the  button on the left to rotate the camera image 90° at each step, and then click on the vertical flip button.

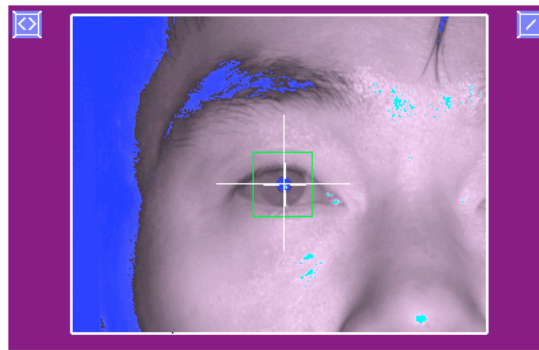

Figure 3-15: Adjusting the Camera Image Orientation

For monocular eye tracking, make sure the eye to be tracked appears in the center of the global view as in Figure 3-15 (the untracked eye may appear near the edge or outside of the camera view, depending on the lens used).

Now place the Host PC mouse cursor on top of the pupil and click on the left mouse button. The camera image for the eye should now be displayed in the zoomed view. If the pupil is detected, a red box and the cross will be drawn on the pupil. This step can also be performed from the Display PC using its mouse by clicking on the pupil in the global image.

Note that when tracking monocularly, the camera should ideally show only the image of the eye to be tracked, with the non-tracked eye not visible. If this is not the case, there is a risk that the eye tracker may switch the eye being tracked. This can be prevented by turning search limits on (the “Use Search Limits” button on the Host PC), but initial camera placement with only one eye visible will guarantee that inadvertent switching of the tracked eye will not occur.

- 2) Use the left or right cursor key to select the zoomed camera view. Adjust the camera focusing by turning the focusing ring on the lens. Performing the adjustments from the side of the mount with the lens will prevent the illumination or the camera’s view from being blocked. Look closely at the eye image on the zoomed view while turning the focusing ring until the eye image is clear. If a turquoise circle (CR signal) appears near the pupil, the best focus will minimize the size of this turquoise circle (see Figure 3-4).

3.2.8.2 Binocular Long Range Participant Setup

Binocular recording is essentially the same as the monocular recording described above, except that the ‘Configuration’ in the Set Options screen should be set to “Long Range Mount (Binoc/Monoc)” and the Camera Head orientation should be angled.

In the global camera view, the eyes should appear in the center of the camera image with the dotted line aligned with the bridge of the nose. For more information about recording in binocular mode, see Section 3.2.2.

3.2.8.3 External Camera Setup and Calibration/Validation

The participant will usually be in different room from the Host or display PCs for Long Range applications such as MEG and MRI, so an External Camera Setup and Calibration and Validation procedure has been developed. To take advantage of this facility, a recent version (1.10.165 or later) of the Experiment Builder software is required.

External Camera Setup is accomplished through the use of response boxes that are configured to trigger the adjustment of thresholds on the Host PC, the initiation of Calibration and Validation, and the controlling of sampling during calibration and validation.

Any response box that has a key press as output can be used, and the software can be configured to map any key onto a variety of setup functions. Discussion of configuring and using the External Camera Setup feature can be found in the Experiment Builder User Manual (version 1.10.165 or later).

Now proceed to section 3.3 “Setting Pupil Threshold” and the rest of the sections for calibration.

3.3 Setting Pupil Thresholds

The camera image of the eye should now be clear, with the pupil centered when the participant looks at the eye image on the Display PC. The pupil threshold may now be automatically set by pressing the ‘Auto Threshold’ button or the ‘A’ key when the camera image is selected. The pupil of the eye should be solid blue, with no other color in the image when the threshold is properly set. If large areas other than the pupil are colored, the participant may have blinked during the ‘Auto Threshold’ procedure: press Auto Threshold again.

If the participant wears eyeglasses, reflections may block the image of the pupil. If the eyeglasses have an anti-reflective coating, image contrast may be poor and pupil tracking may be noisy. These reflections are automatically reduced as much as possible by the EyeLink system; however please be advised that not every participant with glasses will be trackable.

The pupil threshold should be checked by looking at the area within the red box in the image. Figure 3-16 shows the symptoms to look for. If the threshold is too low, the blue area will be smaller than the pupil, and the eye tracker data will be excessively noisy. If the threshold is too high, there will be shadows at the edges and corners of the eye, especially when the eye is rotated. Adjust the pupil threshold by using the pupil threshold adjustment buttons or with the ↑ and ↓ keyboard shortcuts: a mnemonic is to think of the ↑ key as increasing the blue area, and the ↓ key as decreasing the blue area.

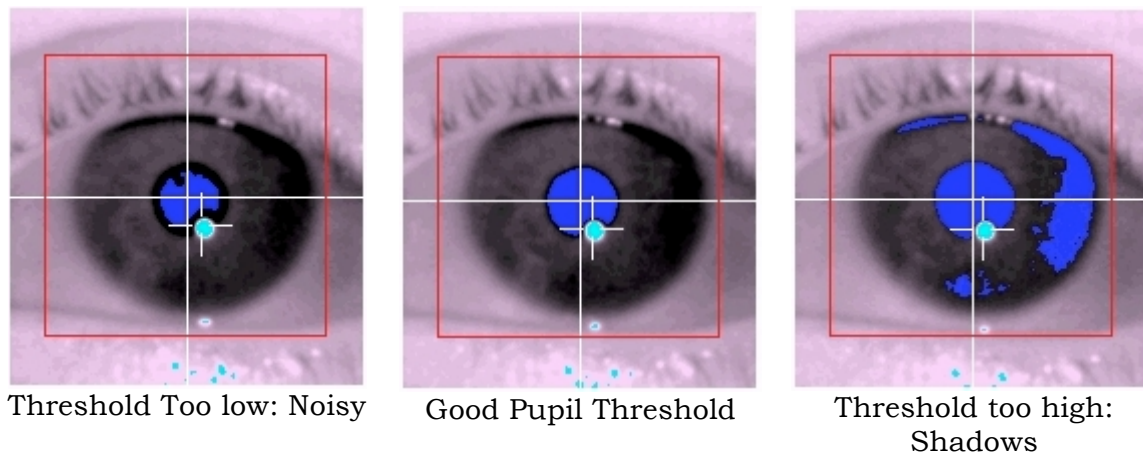

Figure 3-16: Symptoms of Poor Pupil Threshold

The Camera Setup display is updated very rapidly, so noise, shadows, etc. will be easily detected. You can have the participant look at the corners of the monitor, and watch the pupil image for problems. One common problem is for shadows at the corners of the eye, which can capture the pupil (see the right panel of Figure 3-17). These may be eliminated by decreasing the threshold with the ↓ key. Be careful not to drop the threshold too much, as the pupil thresholding may be poor at other eye positions. The pupil on the Host screen should have a cross-hair drawn around its center, indicating that it has been detected. If a shadow captures the pupil, or the pupil is severely under-thresholded (as in the left panel of Figure 3-17), the crosshair and red box will disappear and the pupil will be lost. On the Host PC, a red warning message “No Pupil” will appear below the zoomed eye image.

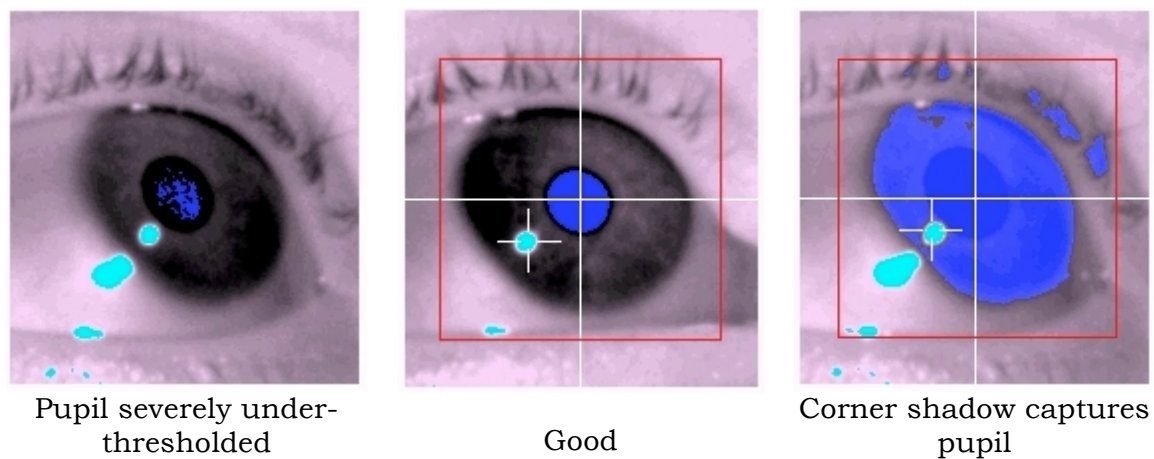

Figure 3-17: Corner Effects Seen with Head Rotation

In general, after threshold adjustment, pupil thresholds should be between 75 and 115 and corneal thresholds should not exceed 240. If the pupil threshold is too low, try increasing the illumination output or decrease the eye-camera distance. If the pupil threshold or corneal thresholds are too high, try reducing the illuminator output or increase the eye-to-camera distance.

EyeLink 1000 Plus Desktop and LCD Arm Mount Users: If the pupil crosshair flickers on and off or becomes missing even though the pupil is clearly visible, then the pupil size may be too small. Please check the camera distance and the illumination level. Consider placing the Desktop Mount closer to the participant (between 40 and 70 cm from the participant’s eye) and/or increasing the illuminator power level.

3.4 Setting the Corneal Reflection (CR) Threshold

For EyeLink 1000 Plus, the “Tracking mode” should almost always be set to pupil-CR mode, regardless whether you plan to use head stabilization or not. The pupil-only mode should only be used with a bite bar. The corneal reflection, if present, is identified by a circular shape in turquoise.

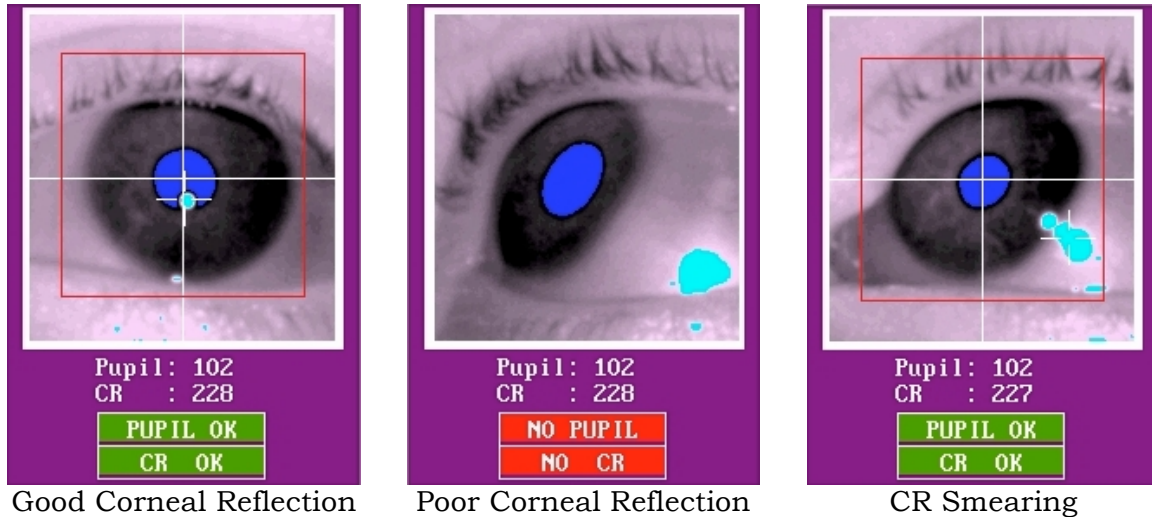

Figure 3-18: Corneal Reflection

Follow the steps below to acquire the best CR:

- Press the Auto Threshold button to set the CR threshold (if this wasn't already done to set the Pupil threshold). You should see a colored circle appear near the pupil on each eye. Auto Threshold should almost always set the correct CR threshold.
- If the auto thresholding sets the threshold too low or high, use the CR threshold buttons, or the + and - keys, to manually adjust the CR threshold.
- Have the participant slowly look along the edges of the display surface and ensure that the corneal reflection does not get lost. If the CR does get lost, a “NO CR” error message will be displayed below the zoomed eye image (see the middle panel of Figure 3-18).
- Another potential problem to look for is CR smearing, which is typically seen when the participant looks at the top-left or top-right corner of the display (see the right panel in Figure 3-18). This is an indication that the viewing angle is too large for the setup. If you see this, try raising the desktop mount and/or increasing the view distance.

NOTE: The corneal reflection may not be stable with all participants, particularly those wearing glasses with a heavy anti-reflection coating. If glass reflections cause difficulties in the proper acquisition of the pupil image, try adjusting the angle of the mirror when using the Tower mount, or adjusting the angle/height of the Desktop mount. If, after adjusting the Tower Mount IR mirror/Desktop Mount optics and reseating the participant, you are unable to acquire a stable corneal reflection, it is suggested that you do not use the participant for the experiment. Unlike the EyeLink II, don't attempt to switch to pupil-only mode to do data collection without using a bite bar.

3.5 Search Limits

The EyeLink 1000 Plus eye tracker provides a “Use Search Limits” option. If enabled, it draws a red box or ellipse in the global view of the camera image to reduce the area of the camera image that is searched to locate the pupil position. If the participant does not wear glasses, you may uncheck the “Use Search Limits” button on the Camera Setup screen. This allows the tracker to search for pupil position across the whole camera image in case the pupil position is lost (e.g., the participant walks away and then comes back reseated to continue the experiment). The “Use Search Limits” button should be checked for participants wearing glasses. This can be used to exclude other regions of the camera image (e.g., frame of the glasses) that may otherwise be detected as a pupil/CR reflection. The disadvantage of using the search limits, however, is that if the participant completely removes the head from the head support and then puts it back, the search limits box may not be in the correct location. This is especially the case when the “Move Limits” button on the Set Options screen is checked. In this case, you will need to click on the pupil image to re-center the search limit box. The search limits are always enabled for the Remote Mode.

The size of the search limit box for the selected eye can be adjusted by pressing ALT and cursor keys on the host keyboard together (ALT + ↑ or ↓ to adjust the height; ALT + ← and ⇒ to adjust the width). The position of the search limits can be adjusted with SHIFT and cursor keys. In a binocular setup, size/position of the search limits need to be adjusted for each eye separately.

3.6 Pupil Tracking Algorithm

EyeLink 1000 Plus eye tracker implements two pupil tracking algorithms: Centroid and Ellipse Fitting. The Centroid mode tracks the center of the thresholded pupil using a center of mass algorithm, whereas the Ellipse mode determines the center of the pupil by fitting an ellipse based on the thresholded

pupil mass. When pupil occlusion is present, the Ellipse mode interpolates points that may drop behind the eyelid or eyelashes in an attempt to better approximate the pupil position. The host software represents the ellipse fitting solution with a green ellipse drawn around the pupil area.

For most applications, the Centroid algorithm is recommended as it has very low noise. However, if the pupil is significantly occluded the Ellipse Fitting algorithm may give a more accurate estimate of the eye position. The Ellipse-Fitting mode decreases drift potential and copes well with pupil occlusion at the cost of a higher noise level and therefore should only be used when Centroid mode may fail.

Remote tracking exclusively uses the Ellipse-Fitting pupil tracking method.

3.7 Calibration

The preceding steps set up the EyeLink 1000 plus eye tracker to track the positions of the pupil and CR of the selected eye. Almost all eye-movement research requires information on the participant's point of gaze on a display of visual information, such as a screen of text. To compute this, we need to determine the correspondence between pupil position in the camera image and gaze position on the display screen. We do this by performing a system calibration, displaying several targets at fixed locations for the participant to fixate. The pupil - CR position for each target is recorded, and the set of target and pupil - CR positions is used to compute gaze positions during recording.

There are several possible calibration types available, each of which serves a different purpose. By default, a nine-point calibration type (“HV9”) is used. This is good for most eye tracking applications. However, if a large calibration region is used, the “HV13” calibration type should be used for the best calibration accuracy. When using the Remote Mode, the 13-point calibration type provides the best recording accuracy. If you record eye movements from a special population that is particularly difficult to calibrate (i.e. infants, or any other population that has difficulty stably fixating over many points), you might consider using fewer calibration points.

Open the Set Options screen by pressing the “Set Options” button from the Camera Setup screen. Check to ensure the following options are selected:

- Calibration type: 13-point for the Remote Mode, 9-point for all other modes
- Randomize target order: YES
- Auto-trigger pacing: 1000 msec

Press the “Previous Screen” button when done to return to Camera Setup.

Begin calibration by pressing the ‘Calibrate’ button from the Camera Setup menu, or by pressing the C key. A calibration target will appear on both the Host PC display and the Display PC monitor. The participant display is drawn by the TRACK application, in response to commands from the EyeLink tracker. The Host PC screen will also display the raw pupil position as a moving letter D (in blue for the right eye and in green for the left eye). The thumbnail images of the eyes and target as well as the relative positions of the eye(s) in the global camera view are displayed in the lower left corner of the screen. A status bar at the bottom-right of the display reports the progress of the calibration.

The pupil-position cursor will move from location to location during the calibration as stable fixations are accepted for each calibration target. Instructing the participant to carefully look at the white spot in the middle of the black calibration target will help improve fixation stability and calibration accuracy. Head movements during calibration should be discouraged: small head movements are corrected, but large movements will severely degrade calibration accuracy, due to distortion of the calibration data pattern and range.

If the cursor jumps continuously and rapidly, or disappears intermittently, the setup for the eye needs to be corrected – the experimenter should go back to the camera setup screen and recheck the camera image as well as the thresholds. The bottom right side of the status bar on the Host PC’s display reports the current eye movement status (e.g., whether the eye is stably fixating or in motion). Eye position will only be accepted when a stable fixation is detected.

When the pupil appears stable, press the “Accept Fixation” button or the ↵ (ENTER) key or spacebar key to accept the first fixation. The pupil tends to come to rest gradually and to make small vergence movements at the start of the fixation, or even make a small corrective saccade so as to foveate the center of the target precisely, so do not respond too quickly. However, do not wait too long before accepting the fixation, as participants tend to make involuntary saccades that move the eye away from the target over time. The proper timing is best learned by watching the gaze cursor during validation (discussed later).

The EyeLink system helps prevent improper triggering by locking out the ↵ key and spacebar if the eye is moving. Sometimes the ↵ key will be locked out because of poor camera setup, with the pupil noisy or undetected in some positions. You can use the ↑ and ↓ keys to change the threshold if required. If this fails, press the ‘ESC’ key to exit back to the Camera Setup screen.

After the first fixation has been accepted, the remaining calibration targets are displayed in sequence and fixations collected for each. The EyeLink calibration

system presents these targets in a random order, which discourages participants from anticipating the location of the next target, and saccading away from the current target before it disappears. However, it is important to remind the participant to look at each calibration target until the next target appears.

If automatic sequencing has been enabled, targets will be presented and fixations collected without further intervention. Each time a new target is displayed, the participant should quickly make a saccade to it. The EyeLink 1000 Plus system detects these saccades and the fixation following, producing an automated sequencing system.

NOTE: Sequencing may halt if the improper setup of the eye causes pupil loss or noise at the target position. If this happens, press the 'ESC' key twice to exit the calibration, adjust the threshold and/or the participant setup, and then restart the calibration. Pressing the 'ESC' once will restart the calibration whereas pressing it twice will exit calibration and return to the Camera Setup menu.

Even though the calibration is automatic, watch the Host PC's display carefully. Note the position of the cross-shaped pupil position markers: these should form a grid shape for the 9-point calibration. Lapses of participant attention will be clearly visible in the movements of this cursor. Also visible will be any difficulties the participant has in fixating targets, and most camera setup problems. The following figure illustrates a good calibration (left panel) and a poor calibration (right panel).

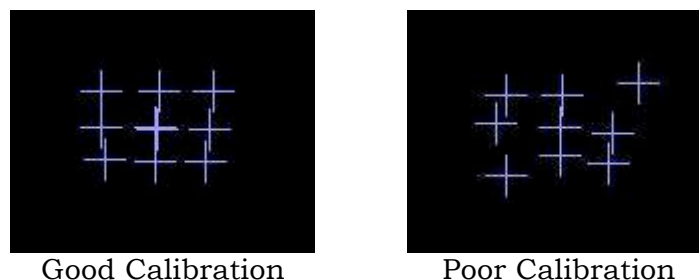

Figure 3-19: Calibration Grid

For some participants (especially those with neurological conditions) short fixations or lapses of attention can make the automated procedure unusable. A manual calibration mode can be used for these participants, where the ↵ (ENTER) key or space key must be pressed to collect each fixation. Pressing the 'M' key switches automatic calibration off. It may be switched back on by pressing the 'A' key.

One useful key in the middle of a calibration sequence is the Backspace key, which can undo recent calibration targets. With each press of this key, data collected for the last point in the calibration sequence is erased and new calibration data can then be collected. This can be used to improve calibration accuracy for one or few selected points without having to restart the calibration procedure. This is especially helpful for those participants whose calibration data is hard to get.

When the last calibration target has been presented, the calibration will be evaluated. At the bottom of the Calibrate screen, each eye's calibration is graded and displayed as follows:

GOOD (green background): No obvious problems found with the data

FAILED: (red background): Could not use data, calibration must be repeated

The background color of the message indicates the usability of the calibration. We must still validate the accuracy of the calibration: only serious problems can be detected here. In particular, please examine the pattern formed by the pupil-position cursors (arrays of crosses) for misplaced or missing fixations. A good calibration is indicated by a regular pattern of parallel horizontal and vertical lines formed by the calibration fixation crosses. If the calibration was successful, you may press the "Accept" button or the ↵ key to accept the calibration results. Pressing the "Restart" button or the 'ESC' key will restart the calibration. Pressing 'ESC' twice exits to the Camera Setup screen. So if you want to keep the current calibration, never press the ESC key at the end of the calibration where the calibration grid is displayed. Doing so will discard the current calibration and thus revert to the existing cached calibration.

Some users (especially the programmers in the phase of testing experiment programs) may want to run calibration and validation with mouse simulation. To do this, start the Host application, set the "Tracking" option in the Set Options screen as "Mouse simulation". Go to the Camera Setup screen, type 'C'. This will bring up the Calibrate screen. Press the space bar once to initiate the calibration process. One cross will be printed on the screen. In addition, the calibration target and the mouse cursor will move to the second calibration point. Press the left mouse button on the Host PC to accept the fixation. Click the left mouse cursor for all of the following calibration targets, until the calibration finishes.

The Status Panel reports the current status for the pupil, corneal-reflection, and target (the latter only in Remote Mode) signals and thus will indicate any lapses in data collection. In normal operation, the indicators should all be green. Should any of the indicators display a color other than green and the

participant is looking at the screen and not blinking, there is a problem with the setup that must be addressed to prevent data loss.

	<p>Indicates Status of Pupil</p> <p>OK = Pupil is visible</p> <p>SIZE = Pupil is too large or too small</p> <p>MISSING = Pupil is missing</p> <p>BOUND = Pupil is missing or the gaze data is not valid</p>
---	---

The pupil status error message “SIZE”, highlighted in yellow, indicates that the size of the pupil is too large or too small. For the Remote Mode, the pupil “SIZE” warning typically suggests that the pupil size is too small because of the ambient lighting or the eye tracker is placed too far away from the participant.

The pupil status error message “MISSING” highlighted in red, indicates that the pupil is missing from the camera view. This could be that the participant is blinking. It could also be that there is a problem with camera setup. Please adjust as needed.

	<p>Indicates Status of Corneal</p> <p>OK = Corneal is visible</p> <p>MISSING = Corneal is missing</p> <p>BOUND = Corneal is missing or the gaze data is not valid</p>
---	---

The corneal status error message “MISSING”, highlighted in red, indicates that the corneal reflection is not visible to the camera. See section 3.4 for details on how to set up corneal reflection properly.

All status flags remain on for a minimum of 200 milliseconds, even if the condition that caused the warning or error to be raised lasts for less than 200 milliseconds.

3.8 Validation

It is important that any problems with the calibration be identified and corrected before eye-movement recordings containing inaccurate and poor quality data are collected. By running a validation immediately after each calibration, the accuracy of the system in predicting gaze position from pupil position can be established. If performance is poor, the calibration/validation cycle should be repeated before data collection begins.

During validation, targets are again presented to the participant in a random order, similar to the calibration procedure. When the participant fixates these,

the calibration model is used to estimate the gaze position of the participant, and the error (difference between actual target position and computed gaze position) is estimated. Note: a scaling factor is built in for automatically generated validation points to pull in the corner positions (see the `'validation_corner_scaling'` command setting in the CALIBR.INI file). This is used to limit validation to the useful part of the display and test the calibration accuracy on uncalibrated points.

The gaze-position error comes largely from errors in fixation data gathered during the calibration/validation, which come from two sources: the eye-tracking system and physiological eye-movement control. The EyeLink system has extremely low pupil-position noise and very high resolution, and corrects for small head motion during calibration and recording. These common sources of error in the eye-tracking system are virtually eliminated. One physiological source of calibration inaccuracy is the natural variability of participants in fixation position on targets. Vergence eye movements also contribute – this can be seen clearly during validation with binocular gaze position displayed.

For calibrations with 9 targets, it is possible that one or more targets may be fixated with an error of 1° or greater. Poor eye/camera setup can cause a highly distorted calibration pattern thus magnifying small errors. Some participants may show substantial drifts in gaze position during fixations or may not fixate carefully, adding to the errors.

To begin the validation procedure, select the “Validate” button or press the ‘V’ key in the Camera Setup screen. The Host PC display will show the gaze position as a round colored cursor. Note the movements of the cursors, and the change in relative horizontal position (vergence) following saccades. Once the cursor appears stable, and close to the target, press the ↵ (ENTER) key or the space bar to accept the first fixation. The remaining points are collected automatically or manually, as in the calibration process.

As each fixation is collected, a cross is used to mark its computed position relative to the target. The error (in degrees) is printed next to the cross. Similar to the calibration procedure, the user can use the “Backspace” key in the middle of a validation sequence to redo data collection for the last or last few validation points collected. After the final fixation is collected, the average and maximum errors are displayed at the bottom of the screen, and the accuracy is scored. Each eye is graded separately, using colored messages similar to the calibration results:

GOOD (green background): Errors are generally acceptable.

FAIR (grey background): Errors are moderate, calibration should be improved.

POOR: (red background): Errors are too high for useful eye tracking.

Note, this categorical scoring of calibration accuracy is a general guideline and different fields of research may choose to use different cut-offs than what is reported above. Always adhere to the convention in your field of research rather than accepting the categorical scoring of calibration accuracy.

Observe the pattern of errors for each target position. If only one target has a large error, the participant may simply have mis-fixated that point, and the validation may be repeated to check this: press 'ESC' to return to the Camera Setup screen, and 'V' to repeat the validation. If a systematic pattern of error is seen (i.e. all fixations on the left side are too low) there is probably a calibration or camera setup problem. In this case, press 'ESC' to return to the Camera Setup screen, adjust the set-up as needed and re-calibrate.

3.9 Improving Calibration Quality

The quality of calibrations determines how useful the recorded data and how accurate the gaze calculation will be. Below are some simple procedures to improve data quality and gaze accuracy:

- Always ask the participant to look at the four corners of the display after performing the camera setup. Be sure to instruct the participant to fixate within the bounds of the display or loss of tracking may occur because they have looked too far outside of the trackable range of the eye tracker not because of a poor set-up. Watch for the warning signals on the tracker screen to make sure that the pupil and CR signal is not lost when the participant is doing so, and check the CR is not becoming distorted or “smeared” when the participant looks at the top corners. Try moving the monitor away to increase the viewing distance and raising the camera when the CR smearing is seen (typically at the upper portion of the display).
- Participants who have never been calibrated before may require some practice in stably and accurately fixating the calibration targets. Try to perform at least two calibrations per participant before beginning to collect data.
- For the Remote Mode, use the 13-point calibration for the best accuracy. For all other modes, use the 9-point calibration type.
- Always check the pattern of the calibration grid. For a 9-point calibration, the fixation crosses should form three parallel horizontal (or close-to-horizontal) lines and three parallel vertical (or close-to-vertical) lines. Redo the calibration or camera setup if you do not see this.

- If the current calibration looks good, press either the ENTER key to accept the calibration or press V to go to validation screen. Never press the ESC key – doing so will discard the current calibration and thus revert to the cached calibration results.
- Encourage participants to sit still! A participant that doesn't sit still probably is not paying proper attention to the experimental task. Try to give the participant a short break in the middle of the experiment and recalibrate before resuming the experiment.
- When writing your own applications, try matching the background color of the calibration and validation screen to that of the experimental displays. Changes in pupil size caused by large changes in brightness between the calibration and the experimental displays will degrade the system accuracy. At the beginning of the experiment, let the participant adapt to the environment and the ambient light levels before performing calibration and data collection. If the illumination levels are altered (i.e. the lights are dimmed) shortly before the experiment begins, the calibration accuracy will be reduced as the participant adapts to the new illumination level and the pupil dilates or constricts.

3.10 Recording Gaze Position

After the system is set up and calibrated, we can monitor gaze position in real time, and record it for later analysis or viewing. Pressing the “Output” button or the ‘O’ key from the Camera Setup screen will display the Output menu, where EyeLink Data Files (*.EDF) can be opened and closed, and analog output (if installed) can be controlled. TRACK.EXE automatically opens a data file ‘SDEMO.EDF’, but you can change this by opening a new file in this menu. Pressing ↵ (ENTER) or ‘O’ again will enter Output mode, and start display of gaze position and data recording.

In this session, we assume the TRACK application is running on the Display PC. When TRACK senses that the Host PC has entered Output mode, it sets up a recording session under its own control.

On the Display PC, it displays a page of text or a grid of letters on its own screen for the participant to read, alternating between recording sessions. The Host PC screen will display a background image of what the participant sees. This serves as a reference for the gaze-position cursor displayed by the EyeLink 1000 Plus during recording, allowing the operator to see where the participant is looking and detect problems with eye-tracking errors or participant’s inattention.

TRACK displays the gaze position as a red cursor on the participant display. The cursor can be toggled on and off by the 'G' key on the Display PC keyboard. To implement this feedback, TRACK requests that EyeLink send it 250, 500, 1000, or 2000 samples per second of gaze-position via the EyeLink Windows DLL. This data is used to move the gaze cursor.

TRACK also sends commands to the Host PC to create a data file (`SDEMO.EDF`) on the Host PC's hard disk, which contains samples, fixations, and saccade data. When the TRACK exits, this file will be automatically transferred from the Host PC to the Display PC. `SDEMO.EDF` may be viewed with EyeLink Data Viewer or processed with other EDF utilities. Information on the EDF file format can also be found in Chapter 4 of the current document.

3.11 Drift Checking and Drift Correction

The "Drift Correct" screen displays a single target to the participant and then measures the difference between the computed fixation position during calibration and the current target. Unlike earlier EyeLink I and II eye trackers, correcting the calibration map based on the drift correction result has no significant effect on gaze accuracy. Therefore, the default drift correction behavior of the EyeLink 1000 Plus system when in pupil-CR mode is to only report the calculated fixation error from the drift correction procedure and to not actually adjust the calibration map in any way. Therefore the drift correction procedure is better viewed as a "Drift Checking" procedure in the EyeLink 1000 Plus in its default configuration.

The user may opt to enable true drift correction if desired. Drift correction can be performed at the beginning of each trial, or part-way through a trial while data are being collected. Regardless of when a drift correction is performed a fixation sample is acquired to a known location and a corrective offset to the raw eye-position data is computed and applied. This can be done by changing the "driftcorrect_cr_disable" command setting in `CALIBR.INI` file. It is important that before performing a drift correction the participant be instructed to sit still and fixate on the drift correction target carefully.

3.11.1 Enabling Drift Correction

Drift Correction may be desirable in some situations, for instance when the EyeLink 1000 Plus is used with the Long Range mount, small changes in pupil size or head position can translate into larger absolute inaccuracies given the larger eye-to-camera distances typically used. Some users prefer true drift correction for other reasons as well – such as expecting pupil size changes from

calibration to testing phases. Whereas it is often better to recalibrate, sometimes the testing situation does not allow for it.

To enable the drift correction procedure to adjust the calibration rather than simply checking that the error level is within a certain range, you may go into the Drift Check screen, and click on the “Apply Correction” button. This will toggle on the button and change the screen mode to “Drift Correct” instead of “Drift Check”. Alternatively, the following EyeLink command should be placed in the FINAL.INI or sent across the link. The default setting in the behavioral laboratory setting is to turn ON the disabling of the drift correction when the CR is being used on the EyeLink 1000 Plus. We are turning this disabling OFF so that the drift correct adjustment will take place.

```
driftcorrect_cr_disable = OFF
```

Another useful parameter to be aware of is the threshold value that is used to determine acceptable error levels in the target fixation that is used to assess drift. The parameter is the ‘drift_correction_rpt_error’ variable (default is 2.0 degrees). If the fixation is not within this level of error, other fixation samples can automatically be taken to ensure that the fixation sample wasn’t itself in error (e.g., attempted during a blink or when the participant was not complying with instructions to fixate the target) or the experimenter can enter into the Camera Setup mode (ESC on the keyboard) and undertake a new camera setup or calibration procedure.

3.11.2 Online Drift Correction

While enabling the standard Drift Correction procedure to update the calibration parameters based on fixating a target between trials can be a solution, it is not always ideal. For instance, sometimes long imaging sessions in MRI, such as in a blocked design, do not lend themselves to the normal drift correct procedure of having the participant frequently look at a target while a sample is taken. For such situations it may be desirable to perform an Online Drift Correction while data recording is underway.

With Online Drift Correction, eye movement recording does not have to be disrupted to introduce an adjustment to the calibration parameters. Some method does however have to be arranged whereby the experimenter knows that the participant is looking at a particular aspect of the stimulus so that the drift correction fixation sample at that known location can be acquired. Pre-arranging that the participant look at a particular aspect of the stimulus display that will act as a fixation target (e.g., a fixation cross), allows the experimenter to perform such drift corrections.

The EyeLink 1000 Plus has two possible online drift correction methods: Drift Correct to Mouse-Click Position and Drift Correct to a Fixed Location. These methods are described in detail below, followed by a list of shared parameters controlling the drift correction behavior.

Only one online drift correction method can be enabled at any one time.

3.11.2.1 Online Drift Correct to Mouse-Click Position

With the mouse-click drift correction method, the experimenter simply initiates the drift correction procedure on the Host PC by clicking on a “Drift Corr” button on the Recording Screen. At this point the button begins to flash on and off and the mouse cursor changes into a circle (see the left panel of Figure 3-20). The experimenter should center the mouse cursor over the position that he/she believes the participant should be fixating and then click the mouse button.

The drift correction will be applied if the difference between the sampled fixation and the mouse click position is within an acceptable range (specified by the `online_dcorr_maxangle` parameter). Once applied the mouse cursor will change back into an arrow, the ‘Drift Corr’ button will cease flashing, and the applied drift correction will be reported (in degrees of visual angle) in the text box at the bottom right of the Recording Screen (see the right panel of Figure 3-20). If the attempted correction is above the acceptable distance then the drift correction will fail and a message will appear in the text box reporting the size of the attempted drift correct and noting it failed such as “DCORR FAILED: offset of 14.6 degrees rejected.”

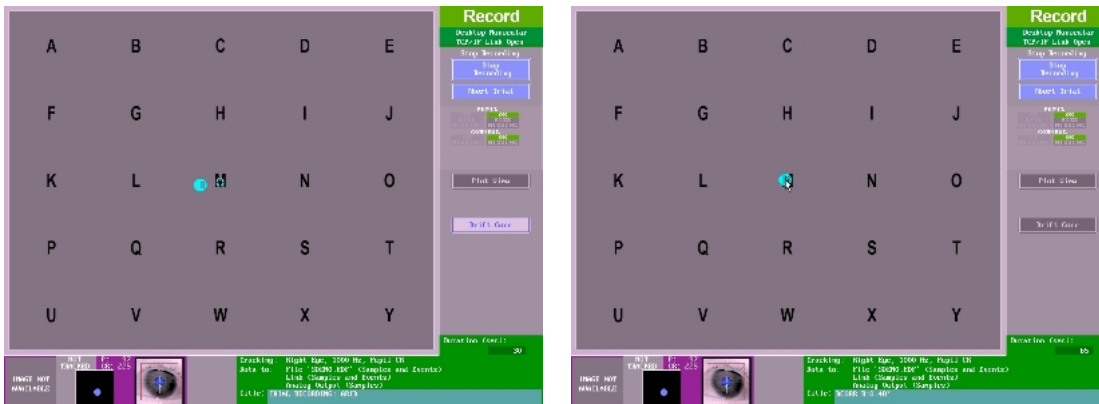

Figure 3-20: Performing a drift correction using mouse click

To enable the online drift correct with a mouse click, the Host PC needs to be configured manually by adding some commands to the FINAL.INI file or it can

be configured through software sending the commands across the link. The required commands are:

```
driftcorrect_cr_disable = OFF  
normal_click_dcorr = ON
```

The variable `online_dcorr_maxangle` specifies the maximum distance in degrees of visual angle that is an acceptable drift correction. This can prevent adjustments greater than this size. The default value is 5.0 degrees of visual angle:

```
online_dcorr_maxangle = 5.0
```

3.11.2.2 Online Drift Correct to a Fixed Location

Using Online Drift Correct to a Fixed Location requires that the coordinate that the participant should fixate is set using an EyeLink command (or predefined in the software). When a drift correction is to be applied the experimenter initiates the correction by clicking the “Drift Corr” button on the Recording Screen of the Host PC or by pressing a prearranged key that will initiate the drift correction.

If the participant regularly fixates some known entity in the displayed image then this could be used to perform the drift correction. When the participant is known to be looking at a fixation cross for instance, simply click the “Drift Corr” button (or press the assigned key – F9 by default) to execute the drift correction. If the attempted correction is above an acceptable distance then the drift correction will fail and a message will appear in the text box reporting the size of the attempted drift correct and noting it failed such as “DCORR FAILED: offset of 14.6 degrees rejected.”

To enable online drift correcting to a fixed location, the Host PC needs to be configured manually by adding some commands to the FINAL.INI file or it can be configured through software sending the commands across the link. The commands required are:

```
driftcorrect_cr_disable = OFF  
online_dcorr_refposn 512,384  
online_dcorr_button = ON  
normal_click_dcorr = OFF
```

After enabling drift correction, these commands set the reference position to which the drift correction will take place. In this example, at the coordinate 512, 384 on the Display PC screen. Next the “Drift Corr” button is enabled on the Recording Screen by turning it on. Finally, the drift correction will be executed by clicking the button.

The drift correction can also be executed when an assigned key is pressed. To do this the following command defines the F9 key to be used to trigger the drift correction action.

```
key_function F9 "online_dcorr_trigger"
```

The variable `online_dcorr_maxangle` specifies the maximum distance in degrees of visual angle that is an acceptable drift correction. This can prevent adjustments greater than this size. The default value is 5.0 degrees of visual angle:

```
online_dcorr_maxangle = 5.0
```

3.12 Exiting the Host Application

You can now close the EyeLink 1000 Plus tracker program. Press the key combination 'CTRL+ALT+Q' from any point in the Host PC tracker program to exit to the File Manager. You can also go to the Offline screen and click on the "Exit EyeLink" button. To perform an orderly shutdown of the Host PC by closing all processes running, go to the Offline screen and click on the "Shutdown Host" button if the host application is still running. From the File Manager, you may click on the red Shutdown button on the toolbar. Now switch off the computer power supply if needed.

3.13 EyeLink 1000 Plus Setup Summary

It is suggested that you try the procedures in this section until you feel comfortable with the EyeLink 1000 Plus setup, and can reliably get good calibrations.

This is a summary of the steps detailed in the practice session. It assumes no setup problems are encountered.

- Start the EyeLink 1000 Plus Host application
- Start TRACK.EXE on the Display PC.
- Have the participant seated in the chair comfortably. Adjust the height of the chair so that the participant's eye line is at the upper part of the monitor.
- Select the appropriate EyeLink Configuration. When using the EyeLink Remote, put the target sticker on the participant's forehead and adjust the position/angle of the Desktop Mount.

- Press ↵ (ENTER) to start Setup mode. Press ENTER again to transfer the camera image to the Display PC.
- Click on the eye image in the global view to properly acquire the pupil to track.
- Focus the camera image if it looks blurred.
- Set the threshold with the 'A' key, and fine-tune with ↑ and ↓ keys. Have the participant look at the four corners of the screen to check pupil/CR image and thresholding.
- Press 'C' to start calibration, press ↵ (ENTER) to collect the first fixation, let the sequence run by itself. Press ↵ (ENTER) to accept result, 'ESC' to discard.
- Press 'V' to start validation, press ↵ (ENTER) to collect the first fixation, let sequence run by itself. Press ↵ (ENTER) when finished.
- Repeat calibration if validation is poor
- Press 'O' 'O' to record eye movement data. 'G' on Display PC keyboard toggles the gaze cursor on and off.
- Press 'CTRL+ALT+Q' to exit the EyeLink 1000 Plus Host PC application.
- Click on the Shutdown button from the File Manager tool bar. Turn off the Host PC and the power to the camera at the end of the day.

3.14 Experiment Practice

The TRACK.EXE program is the most flexible way to practice the EyeLink 1000 Plus setup, allowing almost any sequence of actions to be performed. In real experiments, the sequence of actions is much more defined. Usually the experiment begins with participant setup and calibration from the Setup menu, perhaps followed by practice trials. Then a series of experimental trials are performed, sometimes with a drift correct before each trial.

This flow allows little room for practice, and makes it important that initial setup and calibration be performed correctly and carefully validated. The EyeLink tracker has a built-in trial-abort menu, which may be used in experiments to terminate trials where setup problems are seen. The Setup menu may then be used to fix eye setup or calibration, and the interrupted trial may be restarted or skipped. This sequence requires co-operation from the experiment application, and example code is provided in the developer's kit.

3.15 Next Steps: Other Sample Experiments

For both Windows and Mac OS X, the EyeLink developer's kit contains several sample experiments that are valuable demonstrations of how the EyeLink 1000 Plus system can be used and programmed. On Windows, each sample experiment can be launched from the "Start -> All Programs -> SR Research -> EyeLink Examples -> C Examples -> GDI Graphics (or SDL Graphics)" menu item. On Mac OS X, the examples can be run from "Applications -> EyeLink -> SampleExperiments -> SDL".

All sample experiments have the following key shortcuts that can be used from the Display PC keyboard. These keys are available after the experiment has started and a Data File name has been entered.

ENTER	View camera or accept Calibration / Validation if Calibration / Validation has just been performed
<- or ->	Select the zoomed or global camera view.
C	Perform Calibration
V	Perform Validation
O	Start experiment

The following table describes the purpose and use of each sample experiment. For detailed information on the programming / API aspect of these samples, please refer to the EyeLink Programmer's guide.

Experiment	Purpose
Simple	This experiment is the most basic EyeLink sample experiment that draws directly to the display
Text	Template for an experiment that uses bitmaps to display formatted pages of text
Picture	Template for an experiment that uses bitmaps to display pictures (BMP files)
eyedata	Template for an experiment that uses real-time link data to display a gaze-position cursor, and plays back data after the trial
gcwindow	Template for an experiment that displays text and pictures, using a large gaze-contingent window
control	Template for an experiment that uses the participant's gaze position to select items from a grid of letters

dynamic	Template experiment that includes several types of dynamic displays (sinusoidal smooth pursuit, and saccadic task).
broadcast	Template for an application that listen in on any application, reproducing calibration targets and displaying a gaze cursor (if real-time sample data is enabled).
comm_listener comm_simple	Templates that illustrate a dual-computer experiment. The comm_simple template is a modified version of the simple template, which works with the comm_listener template. This illustrates how real-time data analysis might be performed, by reproducing the display (based on the TRIALID messages) and displaying a gaze cursor.

In addition to the C examples, other programming languages and tools can be used to display experiment stimuli and talk to the eye tracker. For example, Experiment Builder supplies some template experiments (installed at "C:\Users\{User Name}\Documents\ExperimentBuilder Examples" for Windows 7, or "Documents\ExperimentBuilder Examples" on Mac OS X). Each of these experiment templates illustrates a typical experimental paradigm. The following table provides a brief description of the experiments. See the SR Research Experiment Builder User Manual for a detailed description of each template's operations.

Experiment	Purpose
Simple	The basic experiment template, displaying a single word in the center of the screen in each trial. This example is used to introduce how to create an experiment with SR Research Experiment Builder step by step.
Stroop	The basic template for creating non-EyeLink experiments. This template illustrates the use of a results file, RT calculation, and audio feedback, etc.
Picture	Illustrates various parameter settings for showing an image on the screen (in original size versus stretched, centered versus not centered).
TextLine	Experiment to show a single line of text, illustrating the use of runtime interest area.
TextPage	Experiment to show a full screen of text using a multi-line text

	resource.
GCWindow	Demonstrates how to use real-time gaze position to display a gaze-contingent window.
Track	Displays the user's current gaze position during recording and illustrates how to set the resource position contingent on the current gaze position.
Change	Displays several almost identical screens rapidly. It also illustrates the use the of the fixation trigger.
Saccade	Illustrates the creation of a simple experiment for saccade/anti-saccade research.
Pursuit	Illustrates several kinds of sinusoidal movement in a pursuit task.
Video	Illustrates creating an experiment displaying video clips using XVD codec.

4. Data Files

The EDF file format is used by the EyeLink tracker and supporting applications to record eye-movements and other data. It is designed to be space-efficient and flexible, allowing for complete records of experimental sessions and data. It adapts to monocular and binocular recording, with backwards-compatibility for future enhancements. The EyeLink 1000 Plus EDF file format is backwards compatible with the earlier EyeLink I, II, and 1000 EDF file format.

The EDF file format is a platform-portable binary record of eye-position and synchronization events. This format is used directly for EyeLink Data Viewer application, and may be translated by the EDF2ASC utility into a text-format ASC file. This file lists most of the important data in the EDF file in a more easily accessible format, but at the expense of a much larger file size.

Note: By changing the File Sample Filter from Extra to Standard or Off, this will affect EyeLink Data Viewer, EDF2ASC, and other analysis tool data calculations. SR Research Ltd. strongly recommends leaving the “File Sample Filter” setting on the Set Options screen to “Extra”.

4.1 File Contents

The EDF files contain two streams of data: eye-position samples (up to 2000 per second produced from the EyeLink tracker, depending on the system model) and events (eye-movement events such as saccades and fixations, participant responses, and synchronizing events from the experimental application). Both streams are time-synchronized for easy analysis. The file is organized into blocks of data, one for each recording session. Each block may have samples, events, or both. Also, the data items recorded in each sample or event may be configured at recording, and are available at the block start to aid in analysis.

Samples are time-stamped in milliseconds and contain monocular or binocular eye-position data in eye-rotation angle (HREF) or display-gaze coordinates (GAZE). Pupil sizes as area or diameter are also recordable. Samples may also contain eye-movement resolution (used to compute true velocity or saccadic amplitudes), button presses, or the status of digital inputs.

Eye-movement events record eye position changes identified by the EyeLink tracker's on-line parser. These events include fixations, blinks, and saccades. Both the onset and end of these events are marked, allowing samples to be assigned to eye-movement periods without complex algorithms. Important data for analysis such as average position for fixations and peak velocity for saccades is also recorded in the events. Other events record participant responses (such as button presses) and synchronization and data messages from applications. These can be used to record the time of a change in the display, or an experimental condition.

4.2 Recording EDF Files

EDF files are created by the EyeLink 1000 Plus tracker, recording eye-position data, events from the on-line parser, and button and input events. These are recorded only when the tracker is in output (recording) mode. Messages sent from applications on the Display PC through the Ethernet link may be recorded at any time. Recording EDF files involves opening a data file, recording data from one or more sessions in output mode, and closing the file. These operations can be performed manually using the EyeLink 1000 Plus Host application on the Host PC, or remotely from the Display PC through the Ethernet. For both applications, it is important that the screen settings are set up properly for accurate recording of data resolution and velocity calculation.

4.2.1 Recording from the EyeLink 1000 Plus Host PC

In some eye-tracking situations, it is most convenient to initiate the recording of eye movement data directly. For example, displays may be generated by manually-operated equipment, or by non-EyeLink applications. Special provisions must be made to display the calibration pattern in these situations. By using the EyeLink 1000 Plus tracker's Output Screen, files may be opened and closed, and recording sessions may be started and stopped. Refer to Chapter 2 of this manual "*EyeLink 1000 Plus Host Application Operation*" for information.

4.2.2 Recording from the EyeLink API or SR Research Experiment Builder

Most eye-movement research involves running many participants through a sequence of experimental trials, with tens or hundreds of recording blocks per file. This is best done by remote control over the link from an experimental application. The connection from the Display PC to the EyeLink 1000 Plus tracker is implemented by an Ethernet link. Refer to the EyeLink Programmer's Guide or SR Research Experiment Builder User Manual for details on how to use the Display PC software to set up and record EDF files.

4.3 The EyeLink On-Line Parser

The EyeLink 1000 Plus system incorporates a unique on-line parsing system which analyzes eye position data into meaningful events and states (saccades, fixations, and blinks).

4.3.1 Parser Operation

The parser uses velocity and acceleration-based saccade detection methods. Because of the EyeLink 1000 Plus tracker's exceptionally low noise levels and high spatial resolution, very little data filtering is needed and thus delay is kept small. The 250, 500, 1000, or 2000 Hz sampling rate gives a high temporal resolution of 4, 2, 1, or 0.5 milliseconds (Note: Availability of some sampling rates and options depends on the system model and licensing).

For each data sample, the parser computes instantaneous velocity and acceleration and compares these to the velocity and acceleration thresholds. If either is above threshold, a saccade signal is generated. The parser will check that the saccade signal is on or off for a critical time before deciding that a saccade has begun or ended. This check does not affect the recorded time of the saccade start or end, but adds some delay to the real-time events sent through the link.

During each saccade or fixation, data is collected related to the velocity, position, and pupil size. At the end of the saccade or fixation, this data is used to compute the starting, ending, and average position, pupil size and velocity, as well as the peak velocity. Velocity data is also converted into units of degrees per second using real-time resolution information. This data is then used to create events which are sent over the link and/or recorded in an EDF file. See the section 4.5.3 “*Eye Movement Events*” for more information on events.

4.3.2 Parser Limitations

The EyeLink 1000 Plus parser was designed for on-line, low delay identification of saccades and blinks. Detection of very small saccades may require off-line processing, as the special filtering and computation of global velocity cannot be performed on-line. In smooth pursuit research, the parser is less sensitive to small back-up saccades (opposite to the direction of pursuit) than forward saccades, due to the low peak velocity of back-up saccades.

The parser only looks “ahead” in the data a short time to compute velocity and acceleration. This limits the data checking the parser can do. Post-processing or data cleanup may be needed to prepare data during analysis. For example, short fixations may need to be discarded or merged with adjacent fixations, or artifacts around blinks may have to be eliminated.

Nonetheless, the EyeLink 1000 Plus parser does an excellent job in most recording situations. Adjusting the configuration of the parser may help bias its performance for specific applications such as smooth pursuit or reading research. Its performance is easily checked: record eye movements using the display of interest, with both sample and event data. Then view the EDF file with EyeLink Data Viewer or convert the EDF file to an ASC file to see the correspondence between the sample data and the events identified by the parser.

4.3.3 EyeLink Parser Configuration

The saccadic detection parameters for the EyeLink 1000 Plus on-line parser may need to be optimized for the type of experimental investigation being performed. For example, neuropsychophysical researchers may need to detect small saccades amid pursuit or nystagmus, while reading researchers will need to detect only large saccades and will want fixation durations maximized. This section explains the function of, and suggests values for, the most useful parser parameters.

Some experimentation may be required to select the best parameters. The user can try different parser settings and perform recordings with full sample data recorded. The eye-movement data can then be viewed with EyeLink Data Viewer with saccades and blinks overlaid, to confirm the parsing accuracy. Once correct parameters are determined, they can be set by the EyeLink 1000 Plus commands over the link as part of the experimental setup, or the EyeLink 1000 Plus configuration file `PARSER.INI` (`REMPARSE.INI` for the EyeLink Remote) or `FINAL.INI` can be edited to change the default parameters.

4.3.4 Parser Data Type

Three eye-position data types are available from the EyeLink 1000 Plus tracker for each sample: raw pupil position, head-referenced angle, and gaze position (see the section 4.4 “File Data Types” for more information). The parser can use any one of these for detecting saccades and generating data for events.

The parser data type is set by the EyeLink command “`recording_parse_type`”. It can be changed by editing the configuration file `DEFAULTS.INI`, or by sending a command over the link. The text of the command is one of:

```
recording_parse_type = GAZE
recording_parse_type = HREF
```

4.3.5 Saccadic Thresholds

Three thresholds are used for saccade detection: motion, velocity, and acceleration. The values of these are in degrees, degrees/sec, and degrees/sec² respectively.

The velocity threshold is the eye-movement velocity that must be exceeded for a saccade to be detected. A velocity threshold of 22 degrees per second allows detection of saccades as small as 0.3°, ideal for smooth pursuit and psychophysical research. A conservative threshold of 30°/sec is better for reading and cognitive research, shortening saccades and lengthening fixation durations. The larger threshold also reduces the number of microsaccades detected, decreasing the number of short fixations (less than 100 msec in duration) in the data. Some short fixations (2% to 3% of total fixations) can be expected, and most researchers simply discard these.

Use of eye-movement acceleration is important for detection of small saccades, especially in smooth pursuit. Acceleration data has much more noise than velocity data, and thresholds of 4000°/sec² for small saccade detection and 8000°/sec² for reading and cognitive research are recommended. Lower acceleration thresholds will produce false saccade reports. Acceleration data and thresholds for the EyeLink 1000 Plus system may be larger than those reported for analog eye trackers. These systems use multi-pole filters for noise reduction that adds delay and smoothes the data, significantly reducing the measured acceleration.

The saccadic motion threshold is used to delay the onset of a saccade until the eye has moved significantly. A threshold of 0.1° to 0.2° is sufficient for shortening saccades. Larger values may be used with caution to eliminate short saccades: for example, a threshold of 0.4° will always merge fixations separated by 0.5° or less, but may eliminate some 1° saccades as well. The threshold should be set to zero for non-cognitive research, or where statistics such as saccadic duration, amplitude and average velocity are required.

Examples of the commands to set these thresholds are:

```
saccade_velocity_threshold = 30  
saccade_acceleration_threshold = 8000  
saccade_motion_threshold = 0.15
```

4.3.6 Pursuit Thresholds

During smooth pursuit and nystagmus, saccades must be detected against a background of smooth eye motion as fast as $70^\circ/\text{sec}$. While acceleration can be used to detect these saccades, velocity data must also be used for reliable detection of all saccades. The EyeLink 1000 Plus parser raises the saccadic velocity threshold during pursuit by the average velocity over the last 40 milliseconds. This is reliable, and does not degrade parser performance during non-pursuit eye movements.

During long saccades such as a return sweep in reading, this fix up causes the saccadic velocity threshold to be raised. This is not a problem as long as the adjustment is limited, as it helps to prevent prolongation of these saccades by overshoots and glissades. The pursuit threshold limits the amount that the saccadic threshold can be raised. A limit of $60^\circ/\text{sec}$ works well for most pursuit and other research, but may have to be raised if very rapid pursuit or nystagmus is being recorded.

The limit is set in degrees per second. An example of this command is:

```
saccade_pursuit_fixup = 60
```

4.3.7 Fixation Updates

Monitoring eye position or pupil size during fixations usually requires processing all samples produced by the tracker. This is acceptable for file data, but is computationally expensive for real-time systems using data sent via the link. Fixation updates solve this problem by sending updates on eye position, pupil size, velocity etc. at regular intervals during a fixation. The first update is sent one update interval after the start of the fixation, and the last is sent at the end of the fixation. Data is aggregated over a preset period, which lowers data

noise. The interval between updates and the data accumulation period can both be set.

Fixation updates are most useful for real-time display paradigms. In some studies, the participant is required to fixate a target while stimuli are presented. Fixation updates can be used to check gaze position every 100 msec or so. Computer interfaces operated via eye movements is a paradigm dramatically simplified by fixation updates. Actions are triggered by gaze on an active area of the screen for a critical duration. This is implemented simply by counting sequential fixation updates that fall within the area.

Two commands set the fixation update interval and data accumulation period in milliseconds. Usually these are set to the same value. An interval of zero disables fixation update. An update interval of 50 or 100 msec is a good choice:

```
fixation_update_interval = 50
```

```
fixation_update_accumulate = 50
```

4.3.8 Other Parameters

The EyeLink 1000 Plus PARSE.INI configuration file contains other commands that configure the parser. These are of several types:

- Verification delays. These set the time in milliseconds that the parser requires a detector output (saccadic velocity or acceleration thresholds, or missing pupil for blink) to be stable before the parser changes its state and sends events to the data file or link. These values have been determined empirically, and there is little advantage to changing them.
- Parser filter types. Two velocity filters are available: fast and slow. The fast filter works better in most cases. The slow filter is less noise sensitive, but increases saccade duration and decreases sensitivity slightly.
- Saccade extension. This is intended to allow the saccade period to include the lower-velocity start and end of the saccadic period. This is usually disabled, as its effect is minor.
- Internal constants. These MUST NOT be changed.

4.3.9 Sample Configurations

The complete set of commands for the most useful tracker configurations is given below. The cognitive configuration is conservative, is less sensitive to noise and ignores most saccades smaller than 0.6°. The psychophysical configuration is useful for neurological and smooth-pursuit research, and reports very small saccades. It also better estimates saccade durations and average velocities.

Cognitive Configuration:

```
recording_parse_type = GAZE
saccade_velocity_threshold = 30
saccade_acceleration_threshold = 8000
saccade_motion_threshold = 0.1
saccade_pursuit_fixup = 60
fixation_update_interval = 0
```

Psychophysical configuration:

```
recording_parse_type = GAZE
saccade_velocity_threshold = 22
saccade_acceleration_threshold = 3800
saccade_motion_threshold = 0.0
saccade_pursuit_fixup = 60
fixation_update_interval = 0
```

4.3.10 Reparsing EyeLink Data Files

The Host PC parses data in real time in order to make eye events immediately available to the Display PC. These events are recorded in the EDF file for later access by the Data Viewer. The parameters used during the initial parsing are supplied in the REMPARSE.INI for the EyeLink Remote and in PARSER.INI for all other modes of recording.

Occasionally, researchers may wish to evaluate the data using different parametric definitions. The EyeLink 1000 Plus Host PC software supports reparsing existing EyeLink 1000 Plus EDF files. To do this, save the desired saccade detection configurations into a new .INI file. Copy the original EDF file to the current EyeLink host directory (“\ELCL\EXE” by default). From the command prompt, type:

```
./el_tracker -reparse {SOURCE_EDF} {DEST_EDF} -c {configuration_INI_FILE}
```

where {SOURCE_EDF} is the name of the original EDF file;

{DEST_EDF} is the name of the destination EDF file where the parsed data should be saved;

{configuration_INI_FILE} the intended configuration file should be used.

The following example illustrates how to reparse the TEST.EDF file with a new set of parser configurations contained in the PARSER2.INI file and save the

output data to TEST_NEW.EDF. Please note that the commands and files names are case-sensitive.

```
./el_tracker -reparse TEST TEST_NEW -c PARSER2.INI
```

4.4 File Data Types

The data contents of an EDF file are organized in two streams: samples and events. Samples are used to record instantaneous eye position data, while events are used to record important occurrences, either from the experimental application or from changes in the eye data.

Both samples and events can report eye data in several forms. These are discussed in the description of sample data. Eye movement data is parsed by the EyeLink 1000 Plus tracker on-line and used to generate eye-movement events, which are discussed with application messages and button events.

4.4.1 Samples

Samples are records of eye-position, pupil size, and button or input states. The EyeLink 1000 Plus tracker can record up to 2000 samples per second in a monocular tracking mode or up to 1000 samples per second in a binocular tracking mode depending on your system configuration and tracker licensing. Each sample is stored as a binary record in the EDF file, with simple compression used to minimize disk space. Even with compression, recording 1000 samples per second will create very large EDF files: about 15K of data per second.

Each sample may contain several data field, including:

- Time of the sample (timestamp) in milliseconds
- eye position data in gaze, HREF, or RAW data, monocular or binocular
- Pupil size, monocular or binocular
- Button or input port state bits

All samples contain a timestamp, recorded in milliseconds. The time is measured from the time when the tracker software was started. This timestamp makes detection of missing samples possible, as well as simplifying processing of data. Usually all samples produced by the EyeLink 1000 Plus tracker are recorded. Other types of sample data are discussed in greater detail below.

4.4.2 Position Data

Eye position data is produced by the EyeLink 1000 Plus tracker every 0.5, 1, 2 or 4 milliseconds depending on the tracking mode and speed set. It is then processed to compute eye rotation angles and to compensate for participant

head motions. The processed data in one or all of these forms may be recorded in the samples. Data is written as (x, y) coordinate pairs, or two pairs for binocular data. The types of position data available are explained below.

4.4.2.1 PUPIL

Pupil position data is raw (x, y) coordinate pairs from the camera. It has not been converted to eye angles or to gaze position. There may be a non-linear relationship between this data and true gaze position. Pupil position is reported in integer values, with 200 to 400 units per visual degree.

When a calibration has not been performed, the EyeLink system cannot convert pupil data to the more useful data types. Raw pupil position is useful when auto-sequencing calibrations, or when the application wishes to perform its own calibration. Most users will not need this type of data.

4.4.2.2 HREF

The HREF (head-referenced) position data directly measures eye rotation angles relative to the head. It does not take into account changes in participant head position and angle, or distance from the display. However, it may be more accurate for neuro-psychophysical research, as it reflects real eye movement velocities and amplitudes.

The (x, y) coordinate pairs in HREF data reflect the line of sight in the geometric model below:

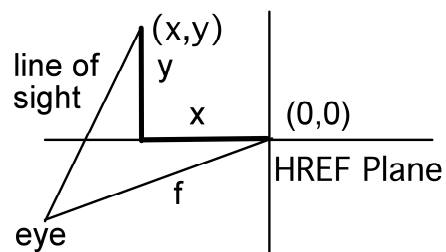

The (x,y) positions define a point in a plane at distance f (15000 units) from the eye. The HREF units are independent of system setup, display distance, and display resolution. The HREF coordinates are reported in integer values, with 260 or more units per visual degree.

The (0, 0) point in the coordinate system is arbitrary, as the relationship between display positions and HREF coordinates changes as the participant's head moves. Even when a chinrest is used to stabilize the participant's head, head rotations of several degrees can occur. HREF coordinates are best used for determining angles relative to a known eye position, or to measure eye-movement velocities, as described below.

The eye rotation angles may be directly computed from the HREF (x, y) pairs. There are several methods of specifying eye-rotation angles. The angular distance (eye rotation magnitude) between any two HREF points is directly

computable. See the formula below. Remember to multiply the result by 57.296 to get the angle in degrees.

$$angle = a \cos\left(\frac{f^2 + x_1 \times x_2 + y_1 \times y_2}{\sqrt{(f^2 + x_1^2 + y_1^2) \times (f^2 + x_2^2 + y_2^2)}}\right)$$

The HREF angular resolution may be computed as the first derivative of the rate of change of HREF position with angle. It is sufficient to compute the resolution separately for the x and y coordinate directions. This may be used to compute true eye-movement velocities, by dividing computed velocity in HREF units by the resolution for the sample. These formulas give the x and y resolution in units of change in HREF position per degree of visual angle:

$$xres = 0.01745 \times \frac{f^2 + x^2 + y^2}{\sqrt{f^2 + y^2}}$$

$$yres = 0.01745 \times \frac{f^2 + x^2 + y^2}{\sqrt{f^2 + x^2}}$$

4.4.2.3 GAZE

Gaze position data reports the actual (x, y) coordinates of the participant's gaze on the display, compensating for distance from the display. The units are in actual display coordinates (usually pixels) which can be set in the EyeLink 1000 Plus configuration file PHYSICAL.INI. The default EyeLink coordinates are those of a 1024 by 768 VGA display, with (0, 0) at the top left.

The resolution data for gaze position data changes constantly depending on participant head position and point of gaze, and therefore is reported as a separate data type (see below). A typical resolution is about 36 pixels per degree for an EyeLink 1000 Plus setup in which the distance between the participant's eyes and the display is twice the display's width, and the screen resolution is set to 1024 by 768.

The high resolution of the EyeLink 1000 Plus data is preserved by multiplying the position by a prescaler, recording the value as an integer in the EDF file, then dividing by the prescaler when the file is read. The usual prescaler value is 10, allowing gaze position to be recorded with 0.1 pixel of resolution. Actual EyeLink 1000 Plus resolution is limited only by measurement noise.

4.4.2.4 Gaze Resolution Data

For gaze position, unlike the HREF data, the relationship between visual angle and gaze position is not constant. The EyeLink 1000 Plus tracker computes and can record the instantaneous angular resolution at the current point of gaze. This is measured as the units (usually pixels) per degree of visual angle, computed for a change in x and y position separately.

This resolution data may be used to estimate distances between gaze positions, and to compute velocities of eye movements. To compute the angular distance of two points, compute the x and y angular distances of the points separately by dividing the distance in pixels by the average of the resolutions at the two points, then compute the Euclidean distance from the x and y distances. For instantaneous velocity in degrees per second, compute the x and y velocities, then divide each by the x or y resolution, square and add the x and y velocities, and take the square root.

Resolution is computed at the point of gaze on the display, and can vary up to 15% over the display. The resolution data in an EDF file is recorded using a prescaler for extra precision, and noted in the gaze-position section.

4.4.3 Pupil Size Data

Pupil size is also measured by the EyeLink 1000 Plus system, at up to 2000 samples per second depending on your tracker version. It may be reported as pupil area, or pupil diameter. The pupil size data is not calibrated, and the units of pupil measurement will vary with participant setup. Pupil size is an integer number, in arbitrary units. Typical pupil area is 100 to 10000 units, with a precision of 1 unit, while pupil diameter is in the range of 400-16000 units. Both measurements are noise-limited, with noise levels of better than 0.2% of the diameter. This corresponds to a resolution of 0.01 mm for a 5 mm pupil.

Pupil size measurements are affected by up to 10% by pupil position, due to the optical distortion of the cornea that accompanies rotations of the eye to view the peripheral parts of the display, and camera-related factors. If you intend to measure pupil size, the participant should not move their eyes during the trials. They can be presented with a fixation point with aural stimulus presentation, or a single stimulus position at display center may be used. It is also possible to counterbalance stimulus position during the experiment. As well, since pupil size is largely affected by luminance, cognitive load, and emotional responses, those factors not being explicitly manipulated must be equated across conditions to achieve a valid measure of pupil size. Lastly, since pupil size is recorded in arbitrary units that is not calibrated across participants, measures of pupil size are best recorded as percent change relative to a baseline period.

4.4.4 Button Data

The state of up to 8 buttons or input port bits may be recorded in each sample. Button ports, bits, and polarity may be set in the EyeLink 1000 Plus tracker configuration file `BUTTONS.INI`.

The button data consists of two 8-bit fields, recorded as a 16-bit number. The lower 8 bits contain the current status of the 8 buttons (bit = 0 if off, 1 if pressed). Each of the upper 8 bits will be set to 1 if its button has changed

since the last sample. The least-significant bit in each byte corresponds to button 1, and the most-significant to button 8.

4.5 Events

One of the most significant aspects of the EyeLink 1000 Plus tracking system and the EDF file format is its on-line processing of eye-movement data to identify and record events such as fixations and saccades. This eliminates the need for recording of sample data for many types of research, and achieves a data compression of 20:1 or greater. Samples need only be recorded for data validation or if sample-by-sample eye position or velocity is required.

Events can record application data such as the time of a display change and experimental conditions, or real-time events such as button presses. Events also define the start and end of blocks of data in the EDF file, allowing applications to process data recorded with different data types.

Each event contains one or two timestamps (in milliseconds) and several data fields. Data for each event is compressed, and an extendable data format allows compatibility with future expanded file formats.

Note that not all the event data listed here is available through the EDF2ASC translator program.

4.5.1 Messages

The most flexible event type is the message event. A message is most often text, but can contain any type of binary data as well, up to a maximum of 300 bytes. Messages are created by the application software, and forwarded over the link to the EyeLink tracker, which timestamps the data and writes it to the EDF file. The application does not need precise time keeping, since link delays are usually very low (on the order of 1 or 2 milliseconds).

Message events are used for two main purposes. They serve to precisely record the time of important events, such as display changes, participant responses, etc. They also record experiment-specific data, such as trial conditions.

Message events consist of a millisecond timestamp, and the message data. For text data, a zero byte at the end of the text is recommended for compatibility with applications written in C. A message data length field provides Pascal string compatibility, and allows binary data to be recorded in the message. Current EyeLink applications only support text messages with zero-terminated strings. It is also recommended that messages be shorter than 120 characters.

4.5.2 Buttons

Each button event records a change in state (pressed or released, 1 or 0) of up to 8 buttons or input port bits, monitored by the EyeLink 1000 Plus tracker. Button ports, bits, and polarity may be set in the EyeLink 1000 Plus tracker configuration file `BUTTONS.INI`.

Each button event contains a timestamp (in milliseconds) of the time the button was pressed, and a word of button data. This consists of two 8-bit fields, recorded as a 16-bit number. The lower 8 bits contain the current status of the 8 buttons (bit = 0 if off, 1 if pressed). Each of the upper 8 bits will be set to 1 if its button has changed since the last sample. The least-significant bit in each byte corresponds to button 1, and the most-significant is button 8.

Button events are usually recorded at the start of each recording block, with all upper 8 bits (change flags) set to 0. This allows applications to track the current button state at all times.

4.5.3 Eye Movement Events

Events are generated by the EyeLink 1000 Plus tracker in real-time from the eye-movement data stream. These provide an efficient record of the data in a form ready to use for most types of eye-movement research. The use of events simplifies the analysis of sample data as well. For example, analysis of pursuit gain requires rejection of saccades, which are clearly marked in the events. Eye-movement events are generated in pairs: one event at the start of an eye-movement condition, and another at the end of the condition. When used in real-time processing with data sent via the link, the event pairs allow an application to monitor eye movement state in real time. These pairs accurately label the samples in a file between the events, as the file is read from beginning to end.

Eye-movement events are always labeled by which eye generated the event. If binocular data is recorded, a separate start and end event is generated for each eye. The time differences between eyes are very important for neurological analysis, for example. The main classes of data events are summarized below.

Start events contain the time of the start of the eye-movement condition. They may also contain the state of the eye at the onset of the condition: for example, the position and pupil size at the start of a fixation.

End events contain both the start and end time of the condition. The end time is actually the time of the last sample in the condition, so length of a condition must be computed as the difference between the end and start times plus the time between samples (1, 2 or 4 milliseconds). End events also contain summary data on the condition as well: average gaze position of a fixation, for example.

Please note that when reading real-time data through the link, the event data will be delayed from the corresponding sample. This is caused by the velocity detector and event validation processing in the host software. The time stamps in the event reflect the true (sample) times.

4.5.3.1 Record Blocks

Each block of recorded data in an EDF file begins with one or both of a STARTSAMPLES or STARTEVENTS event. These contain the time of the recording start, and specify what data can be expected to follow. This allows for flexible adaptation to almost any file-data configuration. Information included in the start events include:

- Which eye recorded from
- Sample data rate
- Sample data contents
- Event data contents
- Event types included
- Gaze-position and velocity prescalers

Each block of recorded data ends with one or both of an ENDSAMPLES or ENDEVENTS event. This simply terminates the data block, and specifies the time that recording ended.

The text files generated from EDF files by the EDF2ASC translator utility create a simplified form of START and END events. A single START or END line is produced for both sample and event blocks, which specifies which eye was recorded from, and whether samples, events, or both, are present in the following data block. Other data is given on following SAMPLES, EVENTS, PRESCALER, etc. lines.

4.5.3.2 Fixations

The on-line EyeLink 1000 Plus tracker parser processes eye-position data, identifying saccades and fixations and compiling data on these conditions. For fixations, these data include:

- The time of the first and last sample in the fixation
- The eye that generated the event
- Average HREF or gaze position data
- Average pupil size
- Gaze-data angular resolution

All of this data may appear in the ENDFIX event that terminates the fixation. Only the starting data can appear in the STARTFIX event that initiates the fixation.

In a sorted EDF file or a text ASC file (produced by EDF2ASC) that contains both samples and events, the STARTFIX event will precede the first sample in the file that is part of the fixation, and the ENDFIX event will follow the last sample in the fixation. This allows the sample data in the files to be processed by saccade or fixation in a single pass.

The data contained in STARTFIX and ENDFIX events may be configured by modifying the DATA.INI file for the EyeLink 1000 Plus tracker. For most research, only simple fixation statistics are required, such as average position and pupil size. By default, STARTFIX events are configured to contain only the start time of the fixation.

Other data in the ENDFIX event may be useful for some types of analysis. The resolution may be used to estimate angular distance between fixations. Angular distance can be calculated by subtracting the x and y position for the fixations, divide by the average corresponding resolution data, and the Euclidean distance:

```
dx = (x1 - x2) / ((rx1 + rx2)/2.0);  
dy = (y1 - y2) / ((ry1 + ry2)/2.0);  
dist = sqrt(dx*dx + dy*dy);
```

4.5.3.3 Fixation Updates

Data within a fixation can be broken into smaller time segments, useful for real-time analysis and control via eye movements. FIXUPDATE events may be produced at regular intervals within a fixation, and contain data for a specified length of time within the fixation. The data recorded in the FIXUPDATE event is similar to that in the ENDFIX event.

FIXUPDATE events are most useful in real-time applications using the link. Recording samples in the EDF file is more useful for most psychophysical research.

4.5.3.4 Saccades

The EyeLink 1000 Plus tracker's parser detects saccades by the velocity and acceleration of the eye movements. Because of variations in acceleration profiles, the onset and offset point of saccades can vary by one or two samples from "ideal" segmentation done by hand. Nonetheless, the saccadic data compiled by the parser is sufficient for most neuro-psychophysical research, including smooth pursuit. Some cognitive research may ignore the saccadic data and only use the fixation data produced by the EyeLink 1000 Plus parser. The saccadic data produced for saccades includes:

- The time of the first and last sample in the saccade
- The eye that generated the event
- Start and end HREF or gaze position data
- Peak eye-movement velocity
- Start and end gaze-data angle.
- Gaze-data angular resolution

All of these data may appear in the ENDSACC event that terminates the fixation. Only the starting data can appear in the STARTSACC event that initiates the saccade.

In a sorted EDF file or a text ASC file (produced by EDF2ASC) that contains both samples and events, the STARTSACC event will precede the first sample in the file that is part of the saccade, and the ENDSACC event will follow the last sample in the saccade. This allows the sample data in the files to be processed by saccade or fixation in a single pass. The data contained in STARTSACC and ENDSACC events may be configured by modifying the DATA.INI file for the EyeLink tracker. Saccadic events may be eliminated entirely, if only fixation data is required. By default, STARTSACC events are configured to contain only the start time of the saccade.

The peak and average velocity data for saccades is especially valuable for neuro-psychophysical work. These are the absolute velocities measured as the Euclidean sum of x and y components. The EyeLink 1000 Plus parser computes velocity by use of a multiple-sample moving filter adjusted for different sampling rates. This is optimal for detection of small saccades, minimizes the extension of saccade durations, and preserves saccadic peak velocities.

Other data in the ENDSACC event may be useful for some types of analysis. The start and end position, and start and end resolution, may be used to compute saccadic amplitude. This is more easily done by multiplying average velocity by the saccadic duration:

$$\text{dist} = 1000.0 * (\text{end_time} - \text{start_time} + 1.0) * \text{avg_velocity};$$

In general, the saccadic amplitude will be slightly less than the distance between average position of the preceding and following fixations, as saccades do not include sub-threshold velocity parts of the eye movement that precede and follow the rapid phase.

4.5.3.5 Blinks

The STARTBLINK and ENDBLINK events bracket parts of the eye-position data where the pupil size is very small, or the pupil in the camera image is missing or severely distorted by eyelid occlusion. Only the time of the start and end of the blink are recorded.

Blinks are always preceded and followed by partial occlusion of the pupil, causing artificial changes in pupil position. These are sensed by the EyeLink 1000 Plus parser, and marked as saccades. The sequence of events produced is always:

- STARTSACC
- STARTBLINK
- ENDBLINK
- ENDSACC

Note that the position and velocity data recorded in the ENDSACC event is not valid. All data between the STARTSACC and ENDSACC events should be discarded. The duration of the blink may be computed by either the duration of the missing pupil between the STARTBLINK and ENDBLINK events, or the difference between the ENDSACC and STARTSACC events in the sequence. Fixation immediately preceding and following blinks should be examined carefully, as they may have been truncated or produced by the blink process. Discarding fixations shorter than 100 ms preceding or following blinks will eliminate most artifacts.

4.6 Setting File Contents

The data recorded in samples and events may be set in the EyeLink 1000 Plus configuration file DATA.INI, and maybe overwritten by the settings in LASTRUN.INI and FINAL.INI. As a result, it is preferred to send those commands to the tracker across the link, via the API `eyecmd_printf()`. Similar commands exist for samples and events sent over the link for real-time applications.

4.6.1 Sample Data

The sample data written to the EDF file is controlled by the "file_sample_data" command, which is followed by a list of data types to include. A single keyword is included for each type:

Keyword	Data Type
LEFT, RIGHT	Sets the intended tracking eye (usually include both LEFT and... RIGHT)
GAZE	includes screen gaze position data
GAZERES	includes units-per-degree screen resolution at point of gaze
HREF	head-referenced eye position data
HTARGET	target distance and X/Y position (EyeLink Remote only)
PUPIL	raw pupil coordinates
AREA	pupil size data (diameter or area)
BUTTON	buttons 1-8 state and change flags
STATUS	warning and error flags
INPUT	input port data lines

The default data is:

```
file_sample_data =
LEFT,RIGHT,GAZE,GAZERES,PUPIL,HREF,AREA,HTARGET,STATUS,INPUT
```

Usually, data for both eyes is enabled, and the menus in the EyeLink 1000 Plus tracker are used to set which eye is actually tracked. Recording of gaze and pupil area is essential for most work, and resolution is important if velocity is to be computed later. Recording of HREF data is optional.

For the EyeLink Remote, the HTARGET flag should always be included in the recording.

4.6.2 Event Data

Eye-movement events are generated by processing one of the types of eye movement data (PUPIL, HREF, or GAZE) as specified by the "recording_parse_type" command (the default setting is GAZE). This command may be edited in the DEFAULTS.INI file of the EyeLink 1000 Plus tracker, or may be sent over the link.

recording_parse_type = <data type: one of PUPIL, HREF, or GAZE>

The data type used for parsing will always be included in the event data. Other data reported for eye-movement events are controlled with the "file_event_data" command. This is followed by a list of data types and options, selected from the list below:

Keyword	Effect
GAZE	includes display (gaze) position data.
GAZERES	includes units-per-degree screen resolution (for start, end of event)
HREF	includes head-referenced eye position
AREA	includes pupil area or diameter
VELOCITY	includes velocity of parsed position-type (average, peak, start and end)
STATUS	includes warning and error flags, aggregated across event (not yet supported)
FIXAVG	include ONLY averages in fixation end events, to reduce file size
NOSTART	start events have no data other than timestamp

The "file_event_data" command may be edited in the DATA.INI file of the EyeLink 1000 Plus tracker, or may be sent over the link. Some example settings are given below:

GAZE,GAZERES,AREA,HREF,VELOCITY	- default: all useful data
GAZE,GAZERES,AREA,FIXAVG,NOSTART	- reduced data for fixations
GAZE,AREA,FIXAVG,NOSTART	- minimal data

4.6.3 Event Types

The "file_event_filter" command specified what type of events will be written to the EDF file. It may be changed in the DATA.INI file of the EyeLink 1000 Plus tracker, or may be sent over the link. The command is followed by a list of data types and options, selected from the list below:

Keyword	Effect
LEFT, RIGHT	Sets the intended tracking eye (usually include both LEFT and RIGHT)
FIXATION	includes fixation start and end events
FIXUPDATE	includes fixation (pursuit) state update events
SACCADE	includes saccade start and end events
BLINK	includes blink start and end events
MESSAGE	includes messages (ALWAYS use)
BUTTON	includes button 1..8 press or release events
INPUT	includes changes in input port lines

These examples of the command are the default event configuration:

```
file_event_filter= LEFT,RIGHT,FIXATION,SACCADE,BLINK,MESSAGE,BUTTON
```

4.7 EDF File Utilities

A number of utility programs are included in the EyeLink 1000 Plus package, to process and view EDF files. The utility EDF2ASC translates EDF files into text ASC files for processing with user applications. EyeLink Data Viewer is an optional tool that allows displaying, filtering, and reporting the output of EyeLink Data Files. Please check EyeLink Data Viewer User's Manual for details.

4.8 Using ASC Files

The EDF file format is an efficient storage format for eye movement data, but is relatively complex to support. To make the data in EDF files accessible, the translator EDF2ASC converts the files into a text version that is easily accessible from almost any programming language. The converted ASC files contain lines of text, with each line containing data for a single sample, event or data parameter.

The EDF2ASC utility reads one or more EDF files, creating text files with the same name but with the ASC extension. It scans the input file, reordering data as required, and converting samples and events into lines of text. It can also compute resolutions and instantaneous velocity for sample data. An ASC file will generally be about twice as large as the original EDF file.

EDF2ASC converter utility can be run from the GUI interface (from your computer desktop, click "Start -> Programs -> SR Research -> EyeLink -> Utilities -> Visual EDF2ASC" assuming that you have installed the EyeLink Data Viewer software). The user can also run the EDF2ASC converter from the DOS command line prompt, assuming that Windows Display Software has been installed. To translate an EDF file from the command line prompt, type

"edf2asc" followed by the name of the file to be translated and any conversion options. Wildcards (* and ?) may be used in the input file name, allowing conversion of multiple EDF files to ASC files with the same name. Optionally, a second file name can be specified for the output ASC file. Many options exist for the file conversion. One set of options will be best for your work, and creation of a single-line batch file (called, for example, E2A.BAT) will make the use of the translator easier. The following table lists commonly-used options.

-l or -nr	outputs left-eye data only if binocular data file
-r or -nl	outputs right-eye data only if binocular data file
-sp	outputs sample raw pupil position if present
-sh	outputs sample HREF angle data if present
-sg	outputs sample GAZE data if present (default)
-res	outputs resolution data if present
-vel	outputs velocity data in samples if possible
-s or -ne	outputs sample data only
-e or -ns	outputs event data only
-nse	blocks output of start events
-nmsg	blocks message event output
-neye	outputs only non-eye events (for sample-only files)
-miss <string>	replaces missing data in ASC file with <string>
-setres <xr> <yr>	uses a fixed <xr>,<yr> resolution always
-defres <xr> <yr>	uses a default <xr>,<yr> resolution if none in file

4.9 The ASC File Format

The ASC file format is defined by the type of data lines that appear in it, the format of these lines, and the order in which these lines occur. Data lines consist of several types:

- Blank or comment lines, which are ignored. The first non-blank character on a comment line is one of "#", "/" or ";".
- File preamble or file-description lines. These begin with "***". Usually these lines are ignored when processing the ASC file.
- Sample data lines. Each line begins with a number, representing the time of the sample.
- Event and data-description lines. Each line begins with a keyword, identifying the type of data in the rest of the line.

4.9.1 ASC File Structure

For sample-only ASC files, file structure is very simple. These files are produced using the "-s" or "-ne" options of EDF2ASC, and only sample data lines are present. There is no data on what type of eye-position data or which eye produced the data. Recording blocks are separated by sample lines consisting of missing-value data (dots or the string specified with the "-miss" option). Gaps in

the sequence of sample timestamps may also be used to determine sample block divisions.

For ASC files containing events (and optionally samples), the order of lines is carefully structured. The file begins with a copy of the EDF file's preamble, with each line preceded by "***". The preamble reports the file version, date created, and any description from the application. Usually the preamble is ignored during analysis.

The sequence of events and samples in the ASC file follows strict rules. These are:

- START events mark the beginning of each recording block, and END events mark the end of each block. The START events also specifies which eye's data is present, and if samples, events, or both are present.
- Data-specification lines follow each START event. These specify the type of data in samples and events in the block, and allow flexible data processing without prescanning the file.
- All eye-movement samples and events occur between the START event and the matching END event.
- All events and samples appear in temporal order. That is, the timestamps of samples, end-time timestamps of eye-movement end events, and start-time timestamps of all other events will be the same or greater than any preceding data.
- Eye-data samples are nested between eye-movement start and end event. For example, the first sample in a fixation will follow the SFIX event for that fixation, and the EFIX event for a fixation will follow the last sample in the fixation. This allows on-the-fly classification of samples as the data file is read.

Before writing an analysis program to process an ASC file, it is helpful to convert a small EDF file containing the data of interest, and examine it with a word processor or print it out.

4.9.2 Sample Line Format

Sample lines contain time, position, and pupil size data. Optionally, velocity and resolution data may be included. Each sample line begins with a timestamp. Recordings done with a 2000 hz sampling rate will have two consecutive rows with the same time stamps. The second row refers to the sample collected at 0.5 ms after the reported time stamp. (To avoid identical time stamps in a 2000 hz recording file, you may consider adding the `-ftime` switch if you do the file conversion from the command prompt, or enable the "Output Float Sample" option in the GUI version of the EDF2ASC converter.) The time stamp field is followed by X and Y position pairs and pupil size data for the tracked eye, and optionally by X and Y velocity pairs for the eye, and resolution X and Y values. Missing data values are represented by a dot ("."), or the text specified by the `"-miss"` option to EDF2ASC.

Several possible sample line formats are possible. These are listed below.

SAMPLE LINE FORMATS

- Monocular:
 <time> <xp> <yp> <ps>
- Monocular, with velocity
 <time> <xp> <yp> <ps> <xv> <yv>
- Monocular, with resolution
 <time> <xp> <yp> <ps> <xr> <yr>
- Monocular, with velocity and resolution
 <time> <xp> <yp> <ps> <xv> <yv> <xr> <yr>
- Binocular
 <time> <xpl> <ypl> <psl> <xpr> <ypr> <psr>
- Binocular, with velocity
 <time> <xpl> <ypl> <psl> <xpr> <ypr> <psr> <xvl> <yvl> <xvr> <yvr>
- Binocular, with and resolution
 <time> <xpl> <ypl> <psl> <xpr> <ypr> <psr> <xr> <yr>
- Binocular, with velocity and resolution
 <time> <xpl> <ypl> <psl> <xpr> <ypr> <psr> <xvl> <yvl> <xvr> <yvr>
 <xr> <yr>

DATA NOTATIONS

<time>	timestamp in milliseconds
<xp>, <yp>	monocular X and Y position data
<xpl>, <ypl>	left-eye X and Y position data
<xpr>, <ypr>	right-eye X and Y position data
<ps>	monocular pupil size (area or diameter)
<psl>	left pupil size (area or diameter)
<psr>	right pupil size (area or diameter)
<xv>, <yv>	instantaneous velocity (degrees/sec)
<xvl>, <yvl>	left-eye instantaneous velocity (degrees/sec)
<xvr>, <yvr>	right-eye instantaneous velocity (degrees/sec)
<xr>, <yr>	X and Y resolution (position units/degree)

4.9.2.1 Samples Recorded in Corneal Reflection Mode

If the data file being processed was recorded using corneal reflection mode, each sample line has an added 3 (monocular) or 5 (binocular) character fields after all other fields (including resolution and velocity if enabled). These fields

represent warning messages for that sample relating to the corneal reflection processing.

- MONOCULAR Corneal Reflection (CR) Samples

- "..." if no warning for sample
 - first character is "I" if sample was interpolated
 - second character is "C" if CR missing
 - third character is "R" if CR recovery in progress

- BINOCULAR Corneal Reflection (CR) Samples

- "....." if no warning for sample
 - first character is "I" if sample was interpolated
 - second character is "C" if LEFT CR missing
 - third character is "R" if LEFT CR recovery in progress
 - fourth character is "C" if RIGHT CR missing
 - fifth character is "R" if RIGHT CR recovery in progress

4.9.2.2 Samples Recorded with the EyeLink Remote

Data files recorded using the Remote Mode have extra columns to encode the target distance, position, and eye/target status information. The first three columns are:

<target x>: X position of the target in camera coordinate (a value from 0 to 10000). Returns "MISSING_DATA" (-32768) if target is missing.

<target y>: Y position of the target in camera coordinate (a value from 0 to 10000). Returns "MISSING_DATA" (-32768) if target is missing.

<target distance>: Distance between the target and camera (in millimeters). Returns "MISSING_DATA" (-32768) if target is missing.

The next thirteen fields represent warning messages for that sample relating to the target and eye image processing.

- "....." if no warning for target and eye image
 - first character is "M" if target is missing
 - second character is "A" if extreme target angle occurs
 - third character is "N" if target is near eye so that the target window and eye window overlap
 - fourth character is "C" if target is too close
 - fifth character is "F" if target is too far
 - sixth character is "T" if target is near top edge of the camera image
 - seventh character is "B" if target is near bottom edge of the camera image
 - eighth character is "L" if target is near left edge of the camera image
 - ninth character is "R" if target is near right edge of the camera image
 - tenth character is "T" if eye is near top edge of the camera image
 - eleventh character is "B" if eye is near bottom edge of the camera image
 - twelfth character is "L" if eye is near left edge of the camera image
 - thirteenth character is "R" if eye is near right edge of the camera image

For a binocular recording, there will be seventeen target/eye status columns, with the last eight columns reporting the warning messages for the left and right eyes separately.

4.9.3 Event Line Formats

Each type of event has its own line format. These use some of the data items listed below. Each line begins with a keyword (always in uppercase) and items are separated by one or more tabs or spaces.

DATA NOTATIONS

<eye>	which eye caused event ("L" or "R")
<time>	timestamp in milliseconds
<stime>	timestamp of first sample in milliseconds
<etime>	timestamp of last sample in milliseconds
<dur>	duration in milliseconds
<axp>, <ayp>	average X and Y position
<sxp>, <syp>	start X and Y position data
<exp>, <eyp>	end X and Y position data
<aps>	average pupil size (area or diameter)
<av>, <pv>	average, peak velocity (degrees/sec)
<ampl>	saccadic amplitude (degrees)
<xr>, <yr>	X and Y resolution (position units/degree)

4.9.3.1 Messages

- MSG <time> <message>

A message line contains the text of a time stamped message. Message is typically sent to the EyeLink 1000 Plus tracker by an application. It contains data for analysis or timestamps important events such as display changes or participant responses. The <message> text fills the entire line after the timestamp and any blank space following it.

4.9.3.2 Buttons

- BUTTON <time > <button #> <state>

Button lines report a change in state of tracker buttons 1 through 8. The <button #> reports which button has changed state. The <state> value will be 1 if the button has been pressed, 0 if it has been released. Tracker buttons may

be created to monitor any digital input port bit, and may be created by link commands or in the tracker configuration file `BUTTONS.INI` or `FINAL.INI`.

4.9.3.3 Block Start & End

- `START <time> <eye> <types>`
- `END <time> <types> RES <xres> <yres>`

`START` lines mark the beginning of a block of recorded samples, events, or both. The start time is followed by a list of keywords which specify the eye recorded from, and the types of data lines in the block. The eye recorded from is specified by "LEFT" for left-eye, "RIGHT" for right-eye, and both "LEFT" and "RIGHT" for binocular. The types of data lines included are specified by "SAMPLES" for samples only, "EVENTS" for events only, and both "SAMPLES" and "EVENTS" for both.

`END` lines mark the end of a block of data. The `<types>` are specified, as it is possible to turn recording of samples and events on and off independently. However, this is not suggested, and for most applications the `<types>` in the `END` line can be ignored. The two values following the "RES" keyword are the average resolution for the block: if samples are present, it is computed from samples, else it summarizes any resolution data in the events. Note that resolution data may be missing: this is represented by a dot (".") instead of a number for the resolution.

4.9.3.4 Fixations

- `SFIX <eye> <stime>`
- `EFIX <eye> <stime> <etime> <dur> <axp> <ayp> <aps>`
- `EFIX <eye> <stime> <etime> <dur> <axp> <ayp> <aps> <xr> <yr>`

The start of fixations are reported with a `SFIX` line, which can be eliminated with the `EDF2ASC "-nse"` option. The `<eye>` is "L" or "R", indicating the eye's data that produced the event.

The end of and summary data on the fixation is reported with the `EFIX` line. This reports the time of the first and last sample in the fixation, and computes the duration of the fixation in milliseconds. The average X and Y eye position (the type of position data is determined when the event was generated) and the average pupil size (area or diameter) are reported. Optionally, the eye-position angular resolution (in units per visual degree) is given as well.

All samples that are within the fixation will be listed between the `SFIX` and `EFIX` event for each eye, simplifying data analysis.

4.9.3.5 Saccades

- SSACC <eye> <stime>
- ESACC <eye> <stime> <etime> <dur> <sxp> <syp> <exp> <eyp> <ampl> <pv>
- ESACC <eye> <stime> <etime> <dur> <sxp> <syp> <exp> <eyp> <ampl> <pv> <xr> <yr>

The start of saccades are reported with a SSACC line, which can be eliminated with the EDF2ASC "-nse" option from the command line prompt or by enabling "Block Start Event Output" from the EDF2ASC converter GUI preference settings. The <eye> is "L" or "R", indicating the eye's data that produced the event.

The end of and summary data of the saccade are reported with the ESACC line. This reports the time of the first and last sample in the saccade, and computes its duration in milliseconds. The X and Y eye position at the start and end of the saccade (<sxp>, <syp>, <exp>, <eyp>) are listed. The total visual angle covered in the saccade is reported by <ampl>, which can be divided by (<dur>/1000) to obtain the average velocity. Peak velocity is given by <pv>. Optionally, the eye-position angular resolution (in units per visual degree) is given as well.

All samples that are within the saccade will be listed between the SSACC and ESACC events for each eye, simplifying data analysis.

4.9.3.6 Blinks

- SBLINK <eye> <stime>
- EBLINK <eye> <stime> <etime> <dur>

Blinks (periods of data where the pupil is missing) are reported by the SBLINK and EBLINK lines. The time of the start of the blink is indicated by the SBLINK line, which can be eliminated with the EDF2ASC "-nse" option. The <eye> is "L" or "R", indicating the eye's data that produced the event. The end and duration are given in the EBLINK event.

Blinks are always embedded in saccades, caused by artificial motion as the eyelids progressively occlude the pupil of the eye. Such artifacts are best eliminated by labeling and SSACC...ESACC pair with one or more SBLINK events between them as a blink, not a saccade. The data contained in the ESACC event will be inaccurate in this case, but the <stime>, <etime>, and <dur> data will be accurate.

It is also useful to eliminate any short (less than 100 millisecond duration) fixations that precede or follow a blink. These may be artificial or be corrupted by the blink.

4.9.4 Data-Specification Lines

Right before each block of recorded data, a few specification lines are written to the EDF file to report the recording information of the trial such as mount type, sampling rate, filtering level, pupil threshold, and pupil tracking algorithm.

- RECCFG <tracking mode> <sampling rate> <file sample filter> <link sample filter> <eye(s) recorded>

This specifies the tracking mode used (pupil-only vs. pupil-CR mode), sampling rate (250, 500, 1000, or 2000 hz), file sample filter (0 – filter off; 1 – standard filter; 2 – extra filter), link/analog filter (0 – filter off; 1 – standard filter; 2 – extra filter), and the eyes (L, R, or LR) recorded in the trial.

- ELCLCFG <mount configuration>

This reports the mount configuration used to do data collection.

Configuration	Typical Setup
MTABLER	Desktop, Stabilized Head, Monocular
BTABLER	Desktop, Stabilized Head, Binocular/Monocular
RTABLER	Desktop (Remote mode), Target Sticker, Monocular
RBTABLER	Desktop (Remote mode), Target Sticker, Binocular/Monocular
AMTABLER	Arm Mount, Stabilized Head, Monocular
ARTABLER	Arm Mount (Remote mode), Target Sticker, Monocular
BTOWER	Binocular Tower Mount, Stabilized Head, Binocular/Monocular
TOWER	Tower Mount, Stabilized Head, Monocular
MPRIM	Primate Mount, Stabilized Head, Monocular
BPRIM	Primate Mount, Stabilized Head, Binocular/Monocular
MLRR	Long-Range Mount, Stabilized Head, Monocular, Camera Level
BLRR	Long-Range Mount, Stabilized Head, Binocular/Monocular, Camera Angled

- GAZE_COORDS <left> <top> <right> <bottom>

This reports the pixel resolution of the tracker recording. Left, top, right, and bottom refer to the x-y coordinates of the top-left and bottom-right corners of display.

- THRESHOLDS <eye> <pupil> <CR>

This reports the pupil and CR thresholds of the tracked eye(s).

- ELCL_PROC <pupil tracking algorithm>

This reports the pupil fitting processing type (i.e., ELLIPSE or CENTROID).

Immediately following a START line, several lines of data specifications may be present. These lines contain more extensive data than the START line about what data can be expected in the START...END block. These are most easily processed by creating a set of flags for each possible data option (left-eye events, right-eye samples, sample velocity, etc.), clearing these when the START

line is encountered, and setting the appropriate flags when keywords ("LEFT", "VEL", etc.) are encountered in a data specification line.

- PRESCALER <prescaler>

If gaze-position data or gaze-position resolution is used for saccades and events are used, they must be divided by this value. For EDF2ASC, the prescaler is always 1. Programs that write integer data may use a larger prescaler (usually 10) to add precision to the data.

- VPRESALER <prescaler>

If velocity data is present, it must be divided by this value. For EDF2ASC, the prescaler is always 1. Programs that write integer data may use a larger prescaler (usually 10) to add precision to the data.

- PUPIL <data type>

This specifies the type of pupil size data (AREA or DIAMETER) recorded in the trial.

- EVENTS <data type> <eye> <data options>

This specifies what types of data is present in event lines, as a sequence of keywords. The <data type> is one of "GAZE", "HREF" or "PUPIL". The eye recorded will be one word ("LEFT" or "RIGHT"). The <data option> keywords currently supported are:

- "RES" for resolution data (both may be present).
- "RATE" for the sample rate (250.00, 500.00, 1000.0, or 2000.0)
- "TRACKING" for the tracking mode (P = Pupil, CR = Corneal Reflection)
- "FILTER" for the filter level used (0=off, 1=standard, 2=extra)

- SAMPLES <data type> <eye> <data options>

This specifies what types of data is present in sample lines, as a sequence of keywords. The <data type> is one of "GAZE", "HREF" or "PUPIL". The eye recorded will be "LEFT" or "RIGHT". The <data option> keywords currently supported are:

- "VEL" for instantaneous velocity data
- "RES" for resolution data (both may be present).
- "RATE" for the sample rate ((250.00, 500.00, 1000.0, or 2000.0)
- "TRACKING" for the tracking mode (P = Pupil, CR = Corneal Reflection)
- "FILTER" for the filter level used (0=off, 1=standard, 2=extra)

4.10 Processing ASC Files

An ASC file is a simple text file, and thus can be accessed by almost any programming language. The usual way to process the file is to read each line

into a text buffer (at least 250 characters in size), and to scan the line as a series of tokens (non-space character groups).

The first token in each line identifies what the line is:

First character in first token	Line type
<no token>	Blank line--skip
# or ; or /	Comment line--skip
*	Preamble line--skip
Digit (0..9)	Sample line
Letter (A..Z)	Event or Specification line

Once the line is identified, it may be processed. Some lines may simply be skipped, and the next line read immediately. For sample lines, the tokens in the line can be read and converted into numerical values. The token "." represents a missing value, and may require special processing. For lines where the first token begins with a letter, processing depends on what the first token is. The tokens after the first are read and desired data from the line are extracted from them. Lines with unrecognized first tokens or with unwanted information can simply be skipped.

Processing of events and samples will depend on what type of analysis is to be performed. For many cognitive eye movement analyses, MSG line text specifying experimental conditions, EFIX event data, and BUTTON event times from each block are used to create data files for statistical analysis. For neurological research, samples between SFIX and EFIX events can be processed to determine smooth-pursuit accuracy and gain. In some cases, an entire block of samples may need to be read and stored in data arrays for more complex processing. For all of these, the organization and contents of the ASC files have been designed to simplify the programmer's task.

5. System Care

5.1 Maintenance

The EyeLink 1000 Plus system should require little maintenance under normal use. If the IR mirror or lens becomes dusty, it can be cleaned with the cleaning cloth we supplied. If the mirror or lens is dirty (e.g., smudged with finger prints), please apply the cleaning solution we supplied and then wipe clean with the cloth. The forehead rest and the chinrest pad may be wiped with a damp cloth if cleaning is required. Additional replacement pads can be purchased; please contact SR Research for details.

5.2 Storage and Transportation

Between uses, it is recommended that the EyeLink 1000 Plus system (head support, camera and mount) be left mounted on the table. If the system is not going to be used for an extended period, you may wish to disconnect the cables from the computer and pack them in the shipping case. The EyeLink 1000 Plus Host PC is a dedicated data collection computer for the eye tracker; users are advised not to use that computer for other purposes.

Important: The Tower Mount should only be held by the vertical posts and should NEVER be held by the mirror or the components attached to the mirror. We recommend you have somebody available to assist in mounting the head-support Tower onto the table to prevent damages to the IR mirror or other parts of the Tower.

For long-term storage, shipping, or transportation, it is recommended that the EyeLink 1000 Plus camera, mounts, and cables be stored in the shipping box that you originally received the system in.

Store the shipping case above freezing and below 40°C, and avoid high-humidity conditions which might cause water to condense within the device and damage the optics. Be sure to follow the unpacking and installation instructions when returning the packaged unit to operation (see the EyeLink 1000 Plus Installation Guide).

6. Important Information

6.1 Safety

6.1.1 Eye Illumination Safety

WARNING: Illuminators must only be connected to EyeLink 1000 Plus camera, and only the supplied cables may be used.

CAUTION: Use of controls or adjustments or performance of procedures other than those specified herein may result in excessive infrared radiation exposure.

CLASS 1 LED DEVICE
IEC 60825-1 (Ed. 1.2:2001)

This system complies with 60825-1 or 62471 safety standards, and is safe under any conditions, including using optical viewing devices and lenses. Illuminators emit invisible IR radiation, which may cause slight discomfort if eye safety instructions are not followed.

The EyeLink DM, AM, PM, and FL series of mounts and illuminators are compliant with current eye safety standards, including the 62471 Lamp Safety standards and the 60825-1 LED safety standard as a Class 1 LED device. These standards have been or are in the process of being adopted by most countries, and regulate many aspects of LED and laser eye safety, including retinal, corneal and skin safety. Class 1 products are “safe under reasonably foreseeable conditions of operation, including the use of optical instruments for intrabeam viewing”.

As these illuminators may be used in situations where they may be viewed for long periods of time, some precautions should be observed. Our experience has been that even safe levels of IR illumination can eventually cause some discomfort due to the slight drying effect of even this low level of illumination. This is especially true for wearers of contact lenses. SR Research recommends that the illuminators not be used for extended periods at distances less than stated in the table below. These will ensure an exposure of less than 1.0 mW/cm² (milliwatts per square centimeter). Exposure decreases as the square of the distance, so even slightly larger distances will reduce exposure significantly.

Illuminator Type	Power Level	Minimum Distance
PM-910 PM-940	preset	150 mm
DM-890	High (100%)	500 mm
DM-850W	Medium (75%)	430 mm
DM-940	Low (50%)	350 mm
DM-850L	High (100%)	650 mm
	Medium (75%)	450 mm
	Low (50%)	300 mm

Table 3: Table of Recommended Distance from Illuminator

In addition to its invisible light output, the illuminators and heatsinks may become warm during operation. Therefore the illuminators should be mounted so as to minimize unnecessary skin contact. If illuminator mounting hardware is provided, be sure to follow the assembly instructions, as these may affect illuminator temperature. Ensure the illuminators are mounted so that air flow is not excessively restricted, as this could also increase the temperature. Mounting the illuminator so that it is clamped directly to a large piece of metal will also help reduce its temperature.

The 850 nm illuminators may be visible as dim red spots during normal operation, while the 890 and 910 nm infrared light from the illuminators is invisible under most viewing conditions. The 940 nm illuminators include a filter to reduce or remove any residual eye response. A faint red glow may be visible in a dark room, usually only after your eyes have adapted to the dark.

NOTE: DO NOT position your eye closer than 100mm (4 inches) from the illuminator for an extended period of time, as this may result in discomfort and unnecessary exposure to heat and high levels of IR light.

The light output of the illuminators may change slightly for a period after power is turned on to the camera and illuminators. For applications where illuminators level is critical, it is recommended that at least 10-15 minutes be allowed for the illuminators to reach a stable temperature before use. This warm-up period will also allow the camera circuitry to reach its operating temperature, resulting in the best image quality at low light levels.

6.2 Servicing Information

WARNING: Changes or modifications to camera, illuminators, or cables not expressly approved by SR Research Ltd. could void the user's warranty and authority to operate the equipment. This includes modification of cables, removal of ferrite chokes on cables, or opening cameras or illuminators.

WARNING: Opening or modifying camera or illuminators, or power supply substitutions, will void the warranty and may affect the safety compliance of the system. No user-serviceable parts inside - contact SR Research for all repairs.

CAUTION: Modification of illuminators, or use of other power supply voltages with this system, may result in excessive exposure to infrared radiation.

6.2.1 Non-Serviceable Components:

In the event of failure, the camera or illuminators should be replaced as a unit, as there are no user serviceable parts inside and no internal adjustments or jumpers. Please contact SR Research for repair or replacement if you suspect these are at fault. There are no user-serviceable parts within any of these components.

6.2.2 Illuminator Replacement:

Before replacing an illuminator, unplug the power supply from the main power and/or unplug the power cable from the camera. Carefully note the routing of illuminator cables and the alignment of the illuminator (if adjustable) in order to restore these during reassembly.

Illuminators are attached to the camera by one or two short cables. On some illuminators, the cable may be unplugged from the illuminator; in other configurations the cable will be permanently attached to the illuminator. The illuminator will be attached to a large metal heat sink, which is used for mounting the unit. Do not attempt to disassemble the illuminator or remove it from its heat sink. Instead, the illuminator unit should be detached by removing the clamps or screws or knobs holding it to its mount.

If the illuminator cable is permanently fastened to the illuminator, unplug the cable(s) from the camera; otherwise you may unplug the cable from the illuminator itself. Dismount the illuminator (instructions for this procedure may be included in documentation for mounting systems).

Re-mount the new illuminator - instructions depend on the mount - restore the routing of the illuminator cable(s), and reconnect the cable to the camera or illuminator.

Reconnect the power supply, start the application software, and check to be sure the illuminator is producing proper output. If the mount allows the angle of the illuminator to be adjusted, it may be necessary to adjust the angle of the illuminator to provide the best illumination of the object of interest.

6.2.3 Cables and Lenses:

The following components are replaceable, if the substitutions are made with components supplied by or approved by SR Research Ltd, or that meet the specifications below.

6.2.3.1 Camera Lenses:

Almost any C-mount lens may be used in the visible spectrum. The high-resolution sensor in the EyeLink 1000 Plus camera performs best with high-resolution machine-vision lenses, and noticeable blurring may be seen at the edges of the image with standard CCTV optics. Please contact SR Research if a C-mount lens is required for your application.

The EyeLink 1000 Plus camera is optimized for near-infrared (850 to 940 nm) use, however performance in this range depends critically on proper lens selection. The majority of C-mount lenses perform poorly beyond 800 nm, with blurry images (especially zoom lenses) or dark images due to loss from optical coatings. Please contact SR Research for a current list of lenses we have approved for IR use.

6.2.3.2 Cables:

The illuminator cables should not be replaced with other cables without the express permission of SR Research. The ferrites on the cable must remain in place and be positioned within 10 cm (4") of the camera. Do not use an illuminator with a damaged cable, as this could result in damage to the camera or intermittent operation.

Any standard Ethernet cable rated for gigabit Ethernet may be used, we recommend high quality CAT-5e or CAT-6 cables, up to 30 meters in length.

A fiber optic cable is required to connect the OC fiber optic camera head. This should be a duplex multimode cable with LC connectors. A power harness is also required to connect the OC and FL to an appropriate power supply. Contact SR Research for connector types and pinouts.

6.2.4 Power Supply Replacement:

WARNING: See the Specifications section for information on the power supply requirements. Use of a power supply with incorrect polarity, voltage, or other ratings may cause safety hazards, void the user's warranty or damage system components.

The EyeLink 1000 Plus camera requires a power supply that is rated for 12VDC and 2A or higher. This supply must have a 2.5mm coaxial ("barrel") power connector (5.5 × 2.5 × 9.5mm). For safety reasons, the power supply must have EN 60950, UL 1950, CSA 22.2 No. 950, or other equivalent safety approval. The power supply should also be labeled "Class 2" or "LPS" for compatibility with the latest safety requirements. SR Research can provide replacements if required, or a list of approved power supplies.

The EyeLink OC fiber optic camera head and FL illuminator require a power supply in the range of 3.6 to 5.6VDC, with a minimum current rating of 2.0A. A special double-shielded power harness is supplied to connect the power supply to the OC and FL units, to eliminate any RF energy leakage in sensitive environments. The power supply requires a 9 pin connector to connect to the

power harness, and the units require a 2-pin polarized LEMO connector. Please contact SR Research if you need details of these connectors.

It is important to ensure that the power supply has a ferrite (the black ring on the cable near the connector) in order to prevent electronic interference being generated. If the new power supply does not have such a ferrite, this should be moved from the old to the new cable, and clamped to the cable within 10 cm of the camera.

6.3 Limited Hardware Warranty

SR Research Ltd.
35 Beaufort Drive,
Ottawa, Ontario, K2L 2B9, Canada

EyeLink 1000 Plus Product Hardware– Limited Warranty

SR Research Ltd. warrants this product to be free from defects in material and workmanship and agrees to remedy any such defect for a period as stated below from the date of original installation.

EyeLink 1000 Plus High-Speed Camera – Two (2) year parts and labor.
EyeLink 1000 Plus Illuminator Module – Two (2) year parts and labor.
EyeLink 1000 Plus Head Support System (excluding gel pads) – Two (2) year parts and labor.
Host PC – Two (2) year parts and labor.

LIMITATIONS AND EXCLUSIONS

This warranty does not apply to any product which has been improperly installed, subjected to usage for which the product was not designed, misused or abused, damaged during shipping, or which has been altered or repaired in any way that affects the reliability or detracts from the performance. Any replaced parts become the property of SR Research Ltd.

Computer system components used with the EyeLink 1000 Plus system are excluded from this warranty unless expressly agreed to be otherwise in writing by SR Research Ltd.; contact the original computer manufacturer for service and support of computer components.

This warranty is extended to the original end purchaser only. Proof of original date of installation is required for warranty service will be performed. This warranty does not apply to the software component of the product. **THIS EXPRESS, LIMITED WARRANTY IS IN LIEU OF ALL OTHER WARRANTIES, EXPRESS OR IMPLIED, EXCLUDING ANY IMPLIED WARRANTIES OF MERCHANTABILITY OR FITNESS FOR A PARTICULAR PURPOSE. IN NO EVENT WILL SR RESEARCH LTD. BE LIABLE FOR ANY SPECIAL, INDIRECT, OR CONSEQUENTIAL DAMAGES.**

In certain instances, some jurisdictions do not allow the exclusion or limitation of incidental or consequential damages, or the exclusion of implied warranties, so the above limitations and exclusions may not be applicable.

WARRANTY SERVICE

For product operation and information assistance, please contact a SR Research Ltd. Support representative (support@sr-research.com). **For product repairs**, please contact your sales representative for appropriate instructions.

6.4 Limited Software Warranty

SR Research Ltd. warrants that the software disks and CD's are free from defects in materials and workmanship under normal use for one (1) year from the date you receive them. This warranty is limited to the original owner and is not transferable.

The entire liability of SR Research Ltd. and its suppliers, and your exclusive remedy, shall be (a) replacement of any disk that does not meet this warranty which is sent with a return authorization number from SR Research Ltd. This limited warranty is void if any disk is damaged has resulted from accident, abuse, misapplication, or service or modification by someone other than SR Research Ltd. Any replacement disk is warranted for the remaining original warranty period or 30 days, whichever is longer.

SR Research Ltd. does not warrant that the functions of the software will meet your requirements or that operation of the software will be uninterrupted or error free. You assume responsibility for selecting the software to achieve your intended results, and for the use and results obtained from the software. SR Research will fix reported software error in a best effort fashion and can not provide a guarantee of solution availability time.

THIS EXPRESS, LIMITED WARRANTY IS IN LIEU OF ALL OTHER WARRANTIES, EXPRESS OR IMPLIED, INCLUDING ANY IMPLIED WARRANTIES OF MERCHANTABILITY OR FITNESS FOR A PARTICULAR PURPOSE. IN NO EVENT WILL SR RESEARCH LTD. BE LIABLE FOR ANY SPECIAL, INDIRECT, OR CONSEQUENTIAL DAMAGES.

Some jurisdictions do not allow limited on the duration of an implied warranty, so this limitation may not apply to you.

In no event shall SR Research Ltd. or its suppliers be liable for any damages whatsoever (including, without limitation, damages for loss of business profits, business interruption, loss of business information, or other pecuniary loss) arising out of use or inability to use the software, even if advised of the possibility of such damages. Because some jurisdictions do not allow an exclusion or limitation of liability for consequential or incidental damages, the above limitation may not apply to you.

6.5 Copyrights / Trademarks

EyeLink is a registered trademark of SR Research Ltd.

All other company and / or product names are trademarks of their respective manufacturers.

Product design and specifications may change at any time without notice.

7. Appendix A: Using the EyeLink 1000 Plus Analog and Digital Output Card

The EyeLink 1000 Plus eye tracking system supports analog output and digital inputs and outputs via a DT334 card. The analog card supplies up to 8 channels of 16-bit resolution analog output, and 16 bits of digital input and 16 bits of digital output. The analog outputs may be used to output up to 6 channels of eye and gaze position data for use by non-link and legacy applications. Digital inputs may be defined as buttons, used for controlling the EyeLink tracker, or recorded to the EDF data file. The outputs may be controlled by 'write_ioport' commands via the link, or used by the EyeLink tracker for data strobes and other functions.

This appendix describes how to configure and use the EyeLink 1000 Plus analog and digital outputs. While some ideas for input and control of the tracker will be introduced, applications are not limited to those introduced here. In addition, other digital input and output ports may be used, including the parallel port of the EyeLink Host PC.

7.1 Analog Data Types

Position data and pupil size data are available in several types, which are selectable through the EyeLink 1000 Plus “Set Options” options screen. For pupil size, either pupil area or pupil diameter may be monitored. These are very high-resolution measurements, with a typical per-unit resolution of 5 μm (0.005 mm). Pupil size measurements are affected by eye position, due to the optics of the eye and camera.

Position data output can be selected from one of three types of measurement:

- Raw:** This measurement is the raw pupil-center position (or pupil minus corneal if running in pupil-CR mode) as measured by the image-processing system. This measurement is available without performing an eye-tracking calibration.
- HREF:** This measurement is related to the tangent of the rotation angle of the eye relative to the head. In the default EyeLink 1000 Plus setup, and for the -5V to +5V output range, it is $5V \cdot \tan(\text{angle})$, measured separately for vertical and horizontal

rotations. A calibration must be performed to properly obtain this measure.

Gaze: This is actual gaze position on the display screen. A calibration must be performed to obtain this measure.

7.2 Analog Data Quality

The EyeLink 1000 Plus analog output system is intended for use with commercial data-collection systems as additional external channels, or for backwards compatibility with existing eye-tracking software and systems. However, analog data transfer may significantly degrade data quality compared to recording to a file or digital transfer via the link. Typically, at least 1 or 2 bits of noise are added by the analog output, cabling, and re-digitization of the analog signal transfer. The typical EyeLink noise level is 0.01 degree RMS: analog data transfer can increase the noise level by a factor of 2 to 20.

The EyeLink 1000 Plus system offers integrated data recording to a file, and digital data transfer through the Ethernet link, which has latency comparable to the analog link and does not suffer from the time base, resolution, and noise degradation inherent in analog systems. SR Research Ltd. is committed to improving access to the Ethernet link data transfer methods, and supplies an analog output option for backwards compatibility with existing experimental systems and as requested by users, but does not encourage its use in new systems.

7.3 Setting up the EyeLink 1000 Plus Analog Card

7.3.1 Installing Analog Output Hardware

To install the analog output card, open the case of EyeLink Host PC, install the card into an empty PCI slot, and secure the rear bracket of the card with the bracket screw. Now start File Manager (press CTRL+ALT+Q from any tracker screen if the host application is running) and click “Configuration -> Devices”. Enable the “ANALOG_OUT”, “DIGITAL_OUT” and “DIGITAL_IN” options of the PCI_Analog_Card from the device list. Click Save and then restart the host computer. The “Set Options” screen of the Host application allows to select the type of data for analog output.

7.3.2 Connections to Analog Card

The analog card is supplied with a connection cable and screw terminal connection board. Analog outputs and digital inputs and outputs are available from this card. Figure 7-1 lists the terminals on the screw terminal panel that correspond to the analog outputs, digital inputs and outputs, and ground or +5V. It is up to each user to determine how to connect and use the analog output connections for their applications. Connections to the analog outputs will depend on what these outputs are connected to - typically this is another computer with an analog input card or an EEG recording system.

Pin Number	Signal Description	Pin Number	Signal Description
1	+5 V Output	2	No Connect
3	Digital Ground	4	Digital I/O Port D, Line 7
5	Digital I/O Port D, Line 5	6	Digital I/O Port D, Line 3
7	Digital I/O Port D, Line 1	8	Digital Ground
9	Digital I/O Port C, Line 7	10	Digital I/O Port C, Line 5
11	Digital I/O Port C, Line 3	12	Digital I/O Port C, Line 1
13	Digital Ground	14	Digital I/O Port B, Line 7
15	Digital I/O Port B, Line 5	16	Digital I/O Port B, Line 3
17	Digital I/O Port B, Line 1	18	Digital Ground
19	Digital I/O Port A, Line 7	20	Digital I/O Port A, Line 5
21	Digital I/O Port A, Line 3	22	Digital I/O Port A, Line 1
23	Digital Ground	24	No Connect
25	No Connect	26	No Connect
27	DAC0 Return	28	DAC0 Output
29	DAC2 Return	30	DAC2 Output
31	DAC4 Return	32	DAC4 Output
33	DAC6 Return	34	DAC6 Output
35	Power Ground	36	No Connect
37	Digital Ground	38	Digital I/O Port D, Line 6
39	Digital I/O Port D, Line 4	40	Digital I/O Port D, Line 2
41	Digital I/O Port D, Line 0	42	Digital Ground
43	Digital I/O Port C, Line 6	44	Digital I/O Port C, Line 4
45	Digital I/O Port C, Line 2	46	Digital I/O Port C, Line 0
47	Digital Ground	48	Digital I/O Port B, Line 6
49	Digital I/O Port B, Line 4	50	Digital I/O Port B, Line 2
51	Digital I/O Port B, Line 0	52	Digital Ground
53	Digital I/O Port A, Line 6	54	Digital I/O Port A, Line 4
55	Digital I/O Port A, Line 2	56	Digital I/O Port A, Line 0
57	Digital Ground	58	No Connect
59	No Connect	60	No Connect
61	DAC1 Return	62	DAC1 Output
63	DAC3 Return	64	DAC3 Output
65	DAC5 Return	66	DAC5 Output
67	DAC7 Return	68	DAC7 Output

Figure 7-1 Screw Terminal Panel Pin Mapping Table

7.3.3 Noise and Filtering

It is very important to make sure these connections are made in a way that does not introduce noise into the data, so connections between the analog output terminals and the analog input terminals must be as short as possible. If the analog input device does not have filters, it may be helpful to add a conditioning filter to each analog connection. A 470 ohm resistor between the output and input, and a 0.1 microfarad capacitor from the input to ground, will filter out most noise sources while not affecting the analog signals (this is a 3.4 KHz low pass filter, which should settle to 1% in 220 microseconds).

7.4 Digital Inputs and Outputs

The digital ports are configured by the EyeLink software with A0-A7 and B0-B7 as inputs, and C0-C7 and D0-D7 as outputs. Digital outputs may be set by the `write_ioport` command, which may be issued through the link or by a button or initialization file command. The port address for the C and D ports on the EyeLink analog output card are 4 and 5, respectively. Digital outputs may also be reserved for EyeLink tracker functions, and writing to these bits has no effect. For example, when analog output is enabled, the data output D7 is used as a strobe output to indicate when new analog data is available.

The digital inputs may be used as buttons and as input port bits, which may be recorded in the EDF data file, or sent as samples via the Ethernet link. Button inputs may be connected to a digital output (such as a parallel port) from a control computer, and assigned functions such as starting and stopping recording, or used as synchronizing marks in the data file. When used as a real button for participant response, the button is typically connected to ground, a 10 K ohm resistor should be connected from the input to one of the +5V terminals on the connection board. Buttons and input ports are defined in `BUTTONS.INI`, with port addresses of 2 for port A, and 3 for port B.

Here is an example of defining a button on port A, and assigning port B as the input port:

```
create_button 8 2 0x01 1 ; button 8, input A0, 0 is active
input_data_ports 3 ;; digital inputs B0..B7 as input port
input_data_mask 0xFF ;; use all bits
```

7.4.1 Analog Data Output Assignments

The EyeLink 1000 Plus hardware outputs analog voltages on 3 to 6 channels, depending on the mode of operation (monocular or binocular) and the analog card configuration. The monocular analog output configuration (set by the "analog_binocular_mapping" command in the ANALOG.INI file) should be used in most cases, as it assigns the eye being actively tracked to the first 3 channels. When binocular mode is selected, left and right eye data is assigned to fixed channels. The analog channel assignments may also be limited to 4 channels (using the "analog_force_4channel" configuration variable in ANALOG.INI). This allows operation with binocular data when few analog inputs are available, and when pupil size data is not required. The results of all combinations of configurations and monocular/binocular eye tracking modes are summarized in the table below, with X and Y representing horizontal and vertical position data, and P representing pupil size data.

Eye tracking mode	Analog output mapping	Channels available	DAC0	DAC1	DAC2	DAC3	DAC4	DAC5
left / right	Monocular	6	X	Y	P	--	--	--
Binocular	Monocular	6	left X	left Y	left P	right X	right Y	right P
Left	Binocular	6	left X	left Y	left P	--	--	--
Right	Binocular	6	--	--	--	right X	right Y	right P
Binocular	Binocular	6	left X	left Y	left P	right X	right Y	right P
left / right	Monocular	4	X	Y	P	--	--	--
Binocular	Monocular	4	left X	left Y	right X	right Y	--	--
Left	Binocular	4	left X	left Y	--	--	--	--
Right	Binocular	4	--	--	right X	right Y	--	--
Binocular	Binocular	4	left X	left Y	right X	right Y	--	--

Table 4: Analog Channel Data Assignments for the EyeLink 1000 Plus hardware

7.4.2 Analog Data Types and Ranges

Both gaze and HREF position data are available for analog output. These are selectable through the EyeLink 1000 Plus tracker's Set Options menu screen. Each of these is scaled to a voltage on the analog output as described below. Raw pupil (or pupil-CR) data is also available for applications that implement their own calibrations.

7.4.3 Scaling of Analog Position Data

Each of the types of position data is scaled to match the selected analog output voltage range. Several variables in ANALOG.INI set what proportion of the expected data range for each type will be represented at the output, and what the total voltage range will be.

- Total analog voltage range is set by `analog_dac_range`, followed by the highest and lowest voltage required. The voltage range may be from -10 to +10 volts, with other typical ranges being -5 to +5, or 0 to +10 volts.
- The fraction of the total data range to be covered is set by the `analog_x_range` and `analog_y_range` variables. These are followed by the data type, and the minimum and maximum range fraction. For example, 0 to 1.0 would cover the full range of the data, 0.1 to 0.9 would cover the central 80% of the data, and -0.2 to 1.2 would add a 20% margin above and below the expected data range. The polarity of the output signals can be inverted by exchanging the lower end and higher end of the `analog_x_range` or `analog_y_range` data range.
- For raw data, the default range is 0.1 to 0.9, because the pupil position will never reach the edges of the camera image. It is possible that the scaled and transformed pupil-CR data might exceed this range, but in general this range will be similar to that of the camera image. Raw data should be assumed to be in arbitrary units.
- For HREF data, the entire data range is assumed to be -30000 to +30000. This is about 127°. This should never be exceeded. The default range setting is therefore 0.0 to 1.0. The HREF data may be recovered from the voltage by the following formula:

$$\text{HREF} = (\text{voltage} - (\text{minvoltage} + \text{maxvoltage}) / 2) * 60000 / (\text{maxvoltage} - \text{minvoltage})$$

- For gaze position data, the data range is scaled to the display coordinates, which are 1024 by 768 at startup, and may be changed via link commands. The data range setting is -0.2 to 1.2, allowing 20% extra range for fixations that map to outside the display. This extra data range allows for identification of fixations outside the display. Scaling to recover gaze position data is more complex, as the numerical value is partially dependent on the display coordinates. The following formulas do the conversion in several stages, with R being the voltage range proportion, and S being the proportion of screen width or height.

$$R = (\text{voltage} - \text{minvoltage}) / (\text{maxvoltage} - \text{minvoltage})$$

$$S = R * (\text{maxrange} - \text{minrange}) + \text{minrange}$$

$$X_{\text{gaze}} = S * (\text{screenright} - \text{screenleft} + 1) + \text{screenleft}$$

$$Y_{\text{gaze}} = S * (\text{screenbottom} - \text{screeentop} + 1) + \text{screeentop}$$

7.5 Pupil Size Data

For pupil size, either pupil area or pupil diameter may be monitored. These are very high-resolution measurements, with resolution as small as 5 microns (0.005 mm). Pupil size measurements are affected by eye position, due to the optics of the eye and camera, and should be considered to be measured in arbitrary units, with a pupil size of zero being represented by the lowest analog voltage.

7.6 Timebase and Data Strobe

The EyeLink 1000 Plus eye tracker samples eye position every 0.5, 1, 2 or 4 ms and outputs analog data at 2000, 1000, 500, or 250 hz (depending on your tracker setting and system licensing). This combination of fast sampling rate and non-continuous output differs from most eye-tracking systems with analog outputs, which either output continuous analog data (such as limbus-tracking systems) or output samples at a lower rate, such as 50/60 Hz video-based tracking systems. This causes the EyeLink analog output to rapidly step between data values, which means that sampling at fixed intervals makes it likely that samples might be missed, sampled twice, or the transition between samples might be recorded instead. Since the EyeLink 1000 Plus tracker and most data-acquisition systems rely on interrupt-driven software sampling and output, it is possible that time base jitter could result in missed samples, or repeated recording of a single eye-position sample. This would appear as a "step" artifact in rapidly-changing eye-position data, such as saccades or pursuit.

7.6.1 Strobe Data Input

The best time base method is to use the EyeLink 1000 Plus analog output strobe, which is assigned to digital output D7 on the analog card connection board. This signal can be configured to be a short or long trigger pulse, which can be used to trigger hardware data acquisition on analog input devices equipped for this, or to trigger interrupt-driven acquisition. The characteristics of this strobe pulse may be set in the ANALOG.INI file, with the strobe being active-high or active-low, and with duration between 5 and 2000 microseconds.

The onset of the strobe is also delayed from the time that analog outputs change, in order to allow outputs to settle to the new voltages. A delay of 400 microseconds is standard, allowing the use of signal-conditioning low pass filters as discussed earlier.

7.6.2 Oversampling and Toggle Strobe

Another possibility is to over sample the analog output, by recording the analog outputs at more than twice the EyeLink 1000 Plus sample rate. This will prevent missed samples, but will still result in steps in the data. Recording the digital strobe output (on an analog or digital input channel) in combination with the analog data allows the first data from each sample to be selected, by detecting the change in value of this output. By setting the duration of the strobe pulse to 0, the strobe output can be set to toggle between high (4 to 5 volts) and low (0 to 1 volt) for every sample, which produces the best signal. Over sampling can also be used without the strobe when the analog data is being used to drive a gaze-contingent display, as the time of each sample is unimportant and over sampling will minimize total data delay.